



MedGyn  
Products, Inc.

# Innovative Products for OB/GYN Professionals

Product Catalog



## Mission

Our mission is to provide trusted products for premier women's healthcare.



## Company Profile

MedGyn specializes in providing unique, high-quality medical devices for Obstetrics and Gynecology professionals. Our product lines include sterile disposable medical devices (single-use), stainless steel instruments, equipment, diagnostic test kits and various OB/GYN procedure kits. MedGyn's products are used in OB/GYN physician offices, multi-practice clinics and hospitals.

For over four decades MedGyn has been a preferred provider of OB/GYN devices throughout the world.

Our company has earned a reputation for high-quality products preferred by OB/GYN physicians.



GENERAL  
GYNECOLOGY



GYNECOLOGY  
ONCOLOGY



INFERTILITY



OBSTETRICS



UROGYNECOLOGY



FAMILY  
PLANNING

## Table of Contents

Colposcopes.....	4
Cryotherapy.....	9
Thermal Ablation System.....	11
Electrosurgery.....	12
Endoscopic Cannulas.....	20
Fetal Monitors.....	21
Dopplers.....	22
Ultrasounds.....	23
Vacuum Pump.....	24
Other Equipment.....	25
Disposables.....	26
Pessaries.....	35
Speculums.....	40
Biopsy Punches.....	45
Tenaculums.....	49
Dilators.....	51
Metal Curettes.....	53
Forceps.....	55
Long-Reach Instruments.....	61
Hysterectomy Instruments.....	63
Scissors.....	64
Needle Holders.....	66

## MedGyn AL-106 HD™ and AL-106™ Digital Video Colposcopes

Different from the traditional optical colposcopes, the AL-106HD™ and AL-106™ are digital colposcopes with an LED light source to ensure ultra-bright visualization and a long life cycle. Its unique optical precision and multiple filters ensures high-definition images and improved visualization of blood vessels.

010466-HD [MedGyn AL-106 High Definition Digital Video Colposcope\\*](#)

010466SA-HD [MedGyn AL-106 High Definition Digital Video Colposcope with Swing Arm\\*](#)



AL-106 HD



### AL-106 HD (Rolling Base)

- High Definition 1.43M pixels (440K for AL-106)
- Extra-bright multi-point LED light source
- 1x - 40x zoom magnification
- Ultra-fast auto-focus technology
- Manual focus option
- Image freeze button
- Built-in video capability
- Green light filter button

010010 [Colposcope Monitor \(Used for AL-101, AL-102, AL-401, AL-105, AL-106\)\\*](#)

010490 [Colposcope Monitor Stand \(Adjustable with Rolling Base\)](#)

## MedGyn Digital Video Colposcopes

The MedGyn AL-106B™ and AL-106 BWL are digital colposcopes that provide similar features as the AL-106 HD and AL-106 but are more affordable options. The AL-106 BWL is also a battery operated wireless colposcope useful in remote areas with limited access to electricity.



AL-106 BWL



AL-106B



AL-106 BWL (Rolling Base)

- Battery operated and wireless
- High-resolution 440,000 pixels
- Bright multi-point LED light source
- 1x - 54x zoom magnification (36x for AL-106 BWL)

AL-106B (Rolling Base)

- Ultra-fast auto focus technology
- Manual focus option
- Image freeze button
- Built-in video capability
- Green light filter button

010471 MedGyn AL-106 BWL Digital Video Colposcope without Software\*

010470 MedGyn AL-106 BWL Digital Video Colposcope with Software\*

010469 MedGyn AL-106B Digital Video Colposcope\*

\*Monitor Sold Separately

## MedGyn Image and Data Management Software

Designed for use with our AL-106 series Colposcopes, MedGyn's Image & Data Management Software allows for the capture and management of colposcopy images into a self-contained patient record. The user-friendly software includes a large offering of standard examination and diagnosis templates, but is easily customized to specific clinical requirements and preferences. This software will automatically create a variety of report options which may include single or multiple colposcopy images.

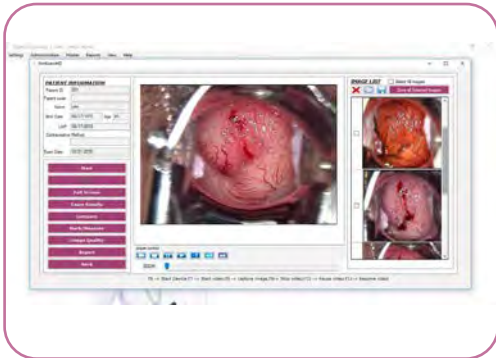
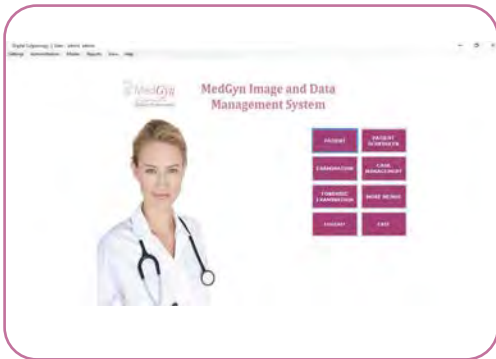

- Image Annotation
- Image Measurement
- Full video capture capability
- Statistical analysis
- Complete system security, internal password protected
- Software includes capture card, security key, and foot switch

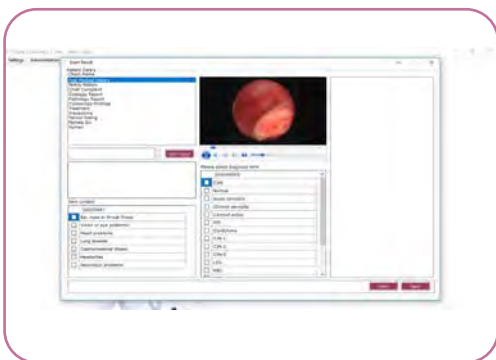

## MedGyn Colposcopy Instrument



- Tischer Biopsy Punch
- Endocervical Speculum
- Graves Speculum
- Endocervical Curette
- Emmet Hook

010477 MedGyn Image and Data Management Software

010476 MedGyn Image and Data Management Software with Laptop (Monitor Sold Separately)

010475 MedGyn Image and Data Management Software with Laptop (Monitor Included)

030350 MedGyn Colposcopy Instrument Set

## MedGyn AL-105 and AL-105Z Colposcopes

MedGyn's AL-105 and AL-105Z Colposcopes are 5-step colposcopes with precision computer designed optics. It is different from the Pro series as the cameras are not integrated, but can be combined with the MedGyn Image and Data Management System.



AL-105 (Rolling Base)

### 010500 MedGyn AL-105 Colposcope (5-Step Magnification)

- Five-step magnification 3x, 4x, 7x, 11x, 17x
- Built-in LED light source with patented integration module
- Ultra-bright light with continuous illumination adjustment
- High-contrast images: Excellent stereoscopic effect
- Great depth of field
- Built-in green filters to increase contrast

### AL-105 Accessories

010514 AL-105 Beam Splitter/Adaptor Combined (Single Port)

010515 AL-105 Beam Splitter (Dual Port)

010516 AL-105 Adapter for CCD Camera

010050 AL-105 CCD Camera

010051 AL-105 HDMI CCD Camera

090025 Power Cord #209-000 - UK

090026 Power Cord #199-000 - Europe

090027 Power Cord #364-010 - Italy

090028 Power Cord #456-010 - South Africa

### 010505 MedGyn AL-105Z Colposcope with Swing Arm (5-Step Magnification)



AL-105Z (Swing Arm)

## MedGyn AL-102 and AL-101 Colposcopes

MedGyn's basic stereoscopic colposcopes AL-102, and AL-101 have become the industry standard by combining high-quality lens systems with easy maneuverability at an attractive price.



AL-102 (Rolling Base)



AL-101 (Rolling Base)

### 010200 MedGyn AL-102 Colposcope

- Interchangeable eyepieces @ 10x, 13.5x, 18x
- 3-position illumination settings
- Complete video and camera system adaptability
- Green filter
- Base with locking caster wheels

### AL-102 Accessories

- 010204 AL-102 10x Eyepiece (set of 2)
- 010205 AL-102 18x Eyepiece (set of 2)
- 010206 AL-102 13.5x Eyepiece (set of 2)
- 010001 AL-102 Video System with Video Pickup and Color Monitor
- 010209 AL-102 Replacement Bulb
- 010207 AL-102 Replacement Fuse

### 010199 MedGyn AL-101 Colposcope

- 1-step magnification: 16x
- High-definition image
- 12.5x eyepieces, 1 fixed/1 moveable
- Green filter
- Adjustable stand





## MedGyn MGC-200 Cryotherapy System

MedGyn Cryotherapy System is designed by physicians and engineered by cryogenic experts to ensure safety, performance and convenience. The MedGyn Cryotherapy System has superior technology combined with a 3-position single trigger to deliver optimal cryosurgical temperatures. A wide variety of autoclavable tips is available. The equipment works with Nitrous Oxide (N<sub>2</sub>O) or with Carbon Dioxide (CO<sub>2</sub>) gas and has standard-specific adaptors.

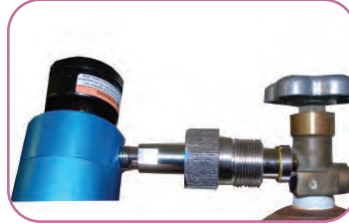

019000 MedGyn Cryotherapy System MGC-200 (tips not included)

- Single-hand control from three-position trigger (freeze, off, defrost)
- Instant defrost
- Wide choice of autoclavable tips
- Valve body designed and manufactured for long, trouble-free life
- Ability to change tip during procedure without shutting off gas flow
- Capture "O" ring design provides complete gas seals where tips attach to probe system
- Built-in regulators control pressure at tip for added safety and gas economy
- Nitrous Oxide (N<sub>2</sub>O) and Carbon Dioxide (CO<sub>2</sub>) adaptors available

### Cryotherapy Equipment & Accessories

019019 Carrying Case for Cryotherapy System

019020 Protective Cap for Cryotherapy System

019021 Rubber Plug 6448K92 for MedGyn Cryo Tip

019030 450 Purifier Housing with 1/4 npt Male Thread Adapter

019031 541 Filter Cartridge for Purifier

019001 Cart for Cylinder, 6lb or 20lb

019003 "O" Ring for Cryo System (3/Pack)

019008 French Adapter for CO<sub>2</sub>

019016 French Adapter For N<sub>2</sub>O

019009 German Adapter for CO<sub>2</sub>

019012 German Adapter for N<sub>2</sub>O

019010 British Adapter for CO<sub>2</sub>

019011 British Adapter for N<sub>2</sub>O

019015 Chinese Adapter for CO<sub>2</sub>

019014 US Adapter for CO<sub>2</sub> (20lb)

019013 US Adapter for N<sub>2</sub>O (20 lb)

019017 US Adapter for N<sub>2</sub>O (6lb)

019018 US Adapter for CO<sub>2</sub> (6lb)



Carrying Case

## MedGyn Cryotherapy Tips

Safe, interchangeable, autoclavable tips are made from a conductive gold alloy, resulting in very rapid freeze and defrost capabilities. Designed to allow for change-out without the need to shut off gas flow, reducing risk of blown "O" ring.

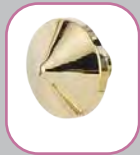

019002/2507 MedGyn Cryotherapy Tip  
GT-2507 Endo/Exocervical Large



019002/2500 MedGyn Cryotherapy Tip  
GT-2500 Exocervical, 25mm Flat

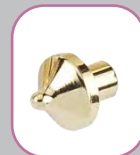

019002/1910 MedGyn Cryotherapy Tip  
GT-1910 Endo/Exocervical Small



019002/1905 MedGyn Cryotherapy Tip  
GT-1905 Exocervical Convex (19mm x  
5mm)



019002/1900 MedGyn Cryotherapy Tip  
GT-1900 Exocervical, 19mm Flat



019002/0811 MedGyn Cryotherapy Tip  
GT-0811 Skin Lesion, 8mm Diameter 45° angle



019002/0800 MedGyn Cryotherapy Tip  
GT-0800 Endocervical, Round



019002/0519 MedGyn Cryotherapy Tip  
GT-0519 Endocervical (Nulliparous)



019002/0507 MedGyn Cryotherapy Tip  
GT-0507 Skin Lesion, 5mm Diameter 45° angle



019002/0219 MedGyn Cryotherapy Tip GT-0219 Micro, 2mm Diameter

## MedGyn MTA-100 Thermal Ablation System

In 2019, WHO issued new guidelines for the use of thermal ablation for cervical pre-cancer lesions. While they continue to recommend cryotherapy, the WHO has offered thermal ablation as an alternative method of treatment for specific environments. MedGyn is pleased to announce its latest device: MedGyn's MTA-100 Thermal Ablation System. The device is a portable, lightweight device for the treatment of pre-cancerous lesions optimized for 20, 40, or 60 second intervals of treatment.

- Optimized to offer 20, 40, or 60 second intervals for procedure
- Bright LED lights for clear viewing of cervical area.
- Sound and light activation for beginning and end of procedure.
- Digital display to detailing temperature at all stages of procedure
- Durable and ergonomic handle for ease of use
- 25mm tip available offering larger treatment area



018003 MedGyn MTA-100 Thermal Ablation System

## MedGyn MTA-100 Tips

Safe, interchangeable, autoclaveable tips are made from a conductive gold alloy, to allow for various pre-cancerous lesion treatment sizes.



019002/2507 MedGyn MTA-100 Tip GT-2507 Endo/Exocervical, Large



019002/2500 MedGyn MTA-100 Tip GT-2500 Exocervical, 25mm Flat



019002/1910 MedGyn MTA-100 Tip GT-1910 Endo/Exocervical, Small



019002/1905 MedGyn MTA-100 Tip GT-1905 Exocervical, Convex (19mm X 5mm)



019002/1900 MedGyn MTA-100 Tip GT-1900 Exocervical, 19mm Flat



## MedGyn Electrosurgical Generators (ES Series)

The MedGyn ES-100, ES-200, ES-300, ES-400 Electrosurgical Generator Series meet all demands for a LEEP/ LLETZ procedure. MedGyn's generators feature both monopolar and bipolar functions to satisfy all surgical demands with safety, flexibility, reliability, and convenience.



ES-200, ES-300, ES-400



ES-100

- Pure cut and blend cut functions
- Contact coagulation and bipolar coagulation
- Displays output power digitally
- Allows operator to check output power easily during the procedure
- Power source: AC120V or AC230V, 50/60 Hz (manual switch)

018015 MedGyn ES-100: Electrosurgical Generator (110-230V)

(Includes Single Foot Switch, Disposable Twin Button Handle, Silicone Patient Plate)

018120 MedGyn ES-200: Electrosurgical Generator (220V)

(Includes Single Foot Switch, Disposable Twin Button Handle, Silicone Patient Plate)

018130 MedGyn ES-300: Electrosurgical Generator (220V)

(Includes Single Foot Switch, Disposable Twin Button Handle, Silicone Patient Plate)

018135 MedGyn ES-400: Electrosurgical Generator (220V)

(Includes Single Foot Switch, Disposable Twin Button Handle, Silicone Patient Plate)

028030 Disposable Handswitch  
Pencil Single Use (10/Pack)

028032 Handswitch Pencil Reusable

028033 Disposable Grounding  
Pad with Cable



028031 Disposable Grounding Pads without Cable

028034 Reusable Cable only for Disposable Grounding pad

## MedGyn Smoke Evacuators

Smoke filtration system minimizes airborne microbes and viruses while removing smoke from site for improved visualization for use during all electrosurgical procedures.



### 018100 MedGyn Smoke Evacuator System (110V)

- Smoke Evacuator Filter
- Smoke Evacuator Tube
- Reducer Fitting

### 018109M MedGyn Smoke Evacuator System SA-01 (220V)

- Smoke Evacuator Filter
- Smoke Evacuator Tube
- Reducer Fitting



### 018109 MedGyn Smoke Evacuator

### Smoke Evacuator Accessories

018105 Smoke Filter Tube - For MedGyn Smoke Evacuator (110V or 220V) (5/Box)

018106 Disposable Smoke Evacuator (DSE) Male tubing 8" (Non-Sterile) (50/Box)

## Bovie A1250S Electrosurgical Generator

The Bovie 1250S is designed to operate as an operating room generator as well as for monopolar and bipolar office surgical procedures.

- 018008 Bovie A1250S Electrosurgical Generator (110-220V)
- 018007 Complete Bovie A1250S-G Electrosurgical System (110V)
- 018010 Complete Bovie A1250S -G Electrosurgical System (220V)

### 1250S Includes:

- A1250S Electrosurgical Generator
- ESP1 Disposable Pencil
- ESO1 Blade, ESO2 Needle, ES20 Ball Electrode
- ESRE Split Return Electrodes
- A1252C Reusable Grounding Cord

### Complete System Includes:

- A1250S Electrosurgical Generator
- SE02 Smoke Shark™ Evacuator
- 786T/SERF 6' Non Sterile Tube and Reducer Fitting
- ESMS-C Mobile Stand and Tray
- ESLK Loop Electrode Kit
- ES07 Extended Ball Disp Electrodes (5/Box)

### A1250S Accessories

- A1202 Solid Dispersive Disposable Grounding Pad (5/Pack)
- ESRS Solid-Return Electrode (50/Box)
- ESRSC Solid-Return Electrode with Cable (50/Box)
- ESRE Split-Return Electrode without Cable (50/Box)
- ESREC Split-Return Electrode with Cable (50/Box)
- ESPR2 Reusable 2-Button Pencil
- ESP1 Disposable 2-Button Pencil with Blade (50/Box)
- ESP6 Disposable Rocker-Switch Pencil with Blade (50/Box)
- ESP7 Disposable Footswitch Control Pencil with Blade (50/Box)
- ESPH Pencil Holster (40/Box)
- ESSP Scratch Pad (40/Box)
- BV1253B Footswitch
- A1255A Adapter For Footswitch



## Bovie A952 Electrosurgical Generator

The Bovie A952 is the first High-Frequency Desiccator with cutting ability. It features Cut, Blend and Coagulation, Fulguration, Bipolar and Micro Bipolar modes.



018006 Bovie A952 Electrosurgical Generator (110-120V)

018005 Complete Bovie A952-G Electrosurgical System (110V)

018009 Complete Bovie A952-G Electrosurgical System (220V)

### A952 Includes:

- A952 Electrosurgical Generator
- A902 Handpiece
- ES01(3), ES02(1), ES20(1) Electrodes
- A1252C Reusable Grounding Cord
- ESRE Split Grounding Pads

### Complete System Includes:

- A952 Electrosurgical Generator
- SE02 Smoke Shark™ Evacuator
- 786T/SERF 6' Non-Sterile Tube and Reducer Fitting
- A812-C Mobile Stand and Tray
- ESLK Loop Electrode Kit
- ES07 Extended Ball Disposable Electrodes (5/Box)

Total system solution combines the electrosurgery unit with a smoke evacuator and mobile stand to produce a compact mobile system for an office or hospital environment.

### A952 Accessories

A1202 Solid Dispersive Disposable Grounding Pad (5/Pack)

ESRS Solid-Return Electrode (50/Box)

ESRSC Solid-Return Electrode with Cable (50/Box)

ESRE Split-Return Electrode without Cable (50/Box)

ESREC Split-Return Electrode with Cable (50/Box)

A901 Reusable 3-Button Pencil

A910 Hand Piece (Pencil) Sheath (100/Box)

ESSP Scratch Pad (40/Box)

A1203 Footswitch

A1203W Waterproof Foot Switch

A905A Adapter for Foot Switch

SE02 Smoke Shark™ Evacuator System (110V)

Includes one 35-hr Filter

SE02-220V Smoke Shark™ Evacuator System (220V)

Includes one 35-hr Filter

### Smoke Shark™ System Accessories

SF35 Smoke Filter - 35-hour

BA-786T Smoke Filter Tube (24/Box)

BA-SERF Reducer Fitting (10/Box)

BA-SERFS Reducer Fitting - Sterile (10/Box)



## MedGyn Disposable Electrodes

Made of high-quality Tungsten wire, for superior shape and integrity, MedGyn offers a full range of shapes and sizes to suit most electrosurgical procedures.



- 028067 Disposable Loop Electrode 5mm x 5mm (5/Pack)
- 028069 Disposable Loop Electrode 10mm x 5mm (5/Pack)
- 028070 Disposable Loop Electrode 10mm x 7mm (5/Pack)
- 028071 Disposable Loop Electrode 10mm x 8mm (5/Pack)
- 028055 Disposable Loop Electrode 10mm x 10mm (5/Pack)
- 028056 Disposable Loop Electrode 10mm x 13mm (5/Pack)
- 028057 Disposable Loop Electrode 15mm x 5mm (5/Pack)
- 028087 Disposable Loop Electrode 15mm X 7mm (5/Pack)

- 028058 Disposable Loop Electrode 15mm x 8mm (5/Pack)
- 028068 Disposable Loop Electrode 15mm x 10mm (5/Pack)
- 028076 Disposable Loop Electrode 15mm x 13mm (5/Pack)
- 028059 Disposable Loop Electrode 15mm x 15mm (5/Pack)
- 028060 Disposable Loop Electrode 20mm x 8mm (5/Pack)



- 028063 Disposable Loop Electrode 20mm x 10mm (5/Pack)
- 028061 Disposable Loop Electrode 20mm x 12mm (5/Pack)
- 028062 Disposable Loop Electrode 20mm x 13mm (5/Pack)
- 028064 Disposable Loop Electrode 20mm x 15mm (5/Pack)
- 028065 Disposable Loop Electrode 20mm x 20mm (5/Pack)
- 028066 Disposable Loop Electrode 25mm x 10mm (5/Pack)

- 028041 Disposable Ball Electrode 3mm (5/Pack)
- 028042 Disposable Ball Electrode 5mm (5/Pack)
- 028081 Disposable Blade Electrode (5/Pack)
- 028053 Disposable Needle 5mm (5/Pack)

- 028075 Disposable Square Loop Electrode 5mm x 5mm (5/Pack)
- 028072 Disposable Square Loop Electrode 10mm x 4mm (5/Pack)
- 028073 Disposable Square Loop Electrode 10mm x 8mm (5/Pack)
- 028074 Disposable Square Loop Electrode 10mm x 10mm (5/Pack)

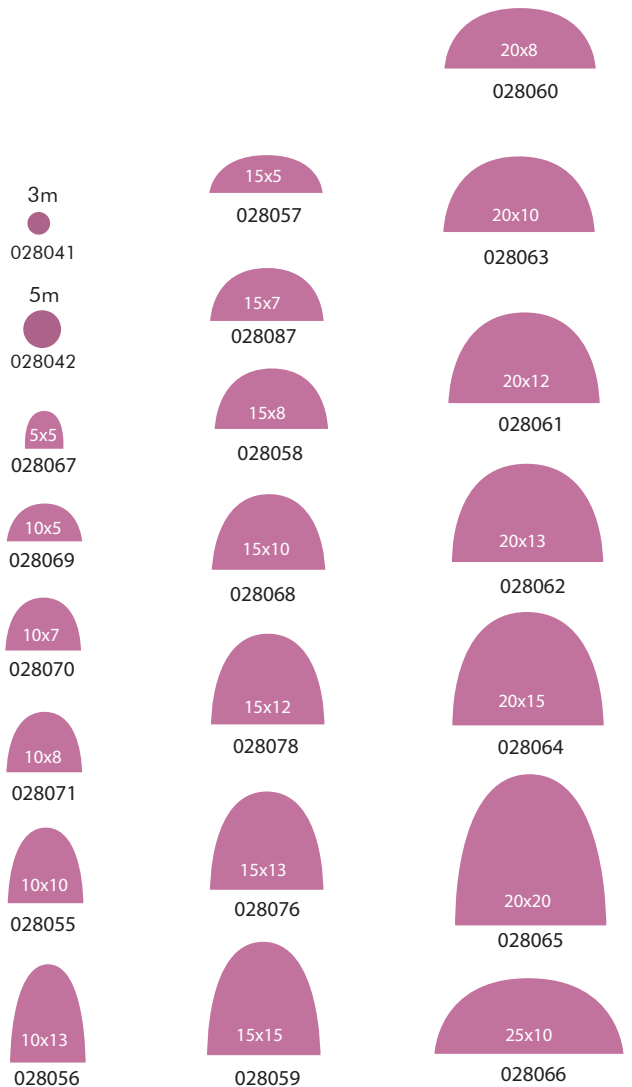



## MedGyn Lletz Instruments - Blue Coated

All MedGyn Lletz instruments have a durable coating to insulate against transmission of electric current, ensuring the highest level of protection for patients and physicians.



### Graves Speculum Closed

- 038030 Small,  $\frac{3}{4}$ " x 3" (19mm x 76mm)
- 038031 Medium,  $1\frac{1}{8}$ " x 4" (35mm x 102mm)
- 038032 Large,  $1\frac{1}{8}$ " x  $4\frac{3}{4}$ " (35mm x 121mm)
- 038033 Extra Large,  $1\frac{1}{2}$ " x  $6\frac{1}{2}$ " (38mm x 165mm)
- 030900-LTZ Extra Long Snowman, Clinton  $1\frac{1}{2}$ " x 6" (38mm x 152mm)

### Graves Vu-More Speculum Closed



- 038055 Medium  $1\frac{1}{4}$ " x 4"  
(32mm x 102mm)
- 038056 Large  $1\frac{3}{8}$ " x  $4\frac{1}{2}$ "  
(35mm x 114mm)

### Graves Vu-Max Speculum Closed Tube



- 038046 Large  $1\frac{3}{8}$ " x  $4\frac{1}{2}$ "  
(35mm x 114mm)

### Graves Vu-More Speculum, (40mm) Opening



- 038115 Small  $3\frac{7}{8}$ " (98mm)
- 038116 Medium  $4\frac{1}{2}$ " (114mm)
- 038117 Large  $4\frac{7}{8}$ " (124mm)
- 038118 Extra Large  $5\frac{7}{8}$ " (149mm)
- 038119 Extra Large  $6\frac{1}{3}$ " (161mm)
- 038120 Extra Large  $6\frac{2}{3}$ " (169mm)
- 038121 Extra Large 7" (178mm)

### Graves Vu-Max Speculum, (70mm) Opening



- 038125 Small  $3\frac{7}{8}$ " (98mm)
- 038126 Medium  $4\frac{1}{2}$ " (114mm)
- 038127 Large  $4\frac{7}{8}$ " (124mm)
- 038128 Extra Large  $5\frac{7}{8}$ " (149mm)
- 038129 Extra Large  $6\frac{1}{3}$ " (161mm)
- 038130 Extra Large  $6\frac{2}{3}$ " (169mm)
- 038131 Extra Large 7" (178mm)



### Pederson Speculum Closed Tube

- 038040 Small,  $\frac{1}{2}$ " x 3" (13mm x 76mm)
- 038041 Medium,  $\frac{7}{8}$ " x 4" (22mm x 102mm)
- 038042 Large, 1" x  $4\frac{3}{4}$ " (25mm x 121mm)
- 038043 Extra Large, 1" x  $6\frac{1}{2}$ " (25mm x 165mm)
- 030917-LTZ Extra Long Snowman, Clinton, 1" x 6" (25mm x 152mm)
- 038044 Medium, Right Side Open  $\frac{7}{8}$ " x 4" (22mm x 102mm)
- 038044-LT Medium, Left Side Open  $\frac{7}{8}$ " x 4" (22mm x 102mm)
- 038045 Large, Right Side Open 1" x  $4\frac{3}{4}$ " (25mm x 121mm)
- 038045-LT Large, Left Side Open 1" x  $4\frac{3}{4}$ " (25mm x 121mm)

## MedGyn Lletz Instruments - Blue Coated

### Pederson Vu-More Speculum, (40mm) Opening



038100 Medium 4½" (114mm)  
038101 Large 4⅞" (124mm)  
038102 Extra Large 5⅝" (149mm)

### Pederson Vu-Max Speculum, (70mm) Opening



038110 Medium 4½" (114mm)  
038111 Large 4⅞" (124mm)  
038112 Extra Large 5⅝" (149mm)

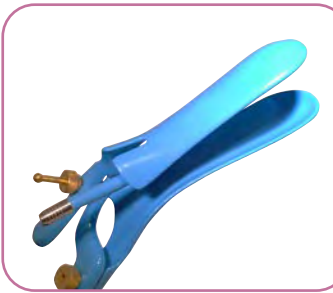

### Weisman Open Side Speculum Closed Tube

038050 Right Side Open Medium 1⅜" x 4" (35mm x 102mm)  
038050-ANG Right Side Open Medium Angled 1⅜" x 4" (35mm x 102mm)  
038052 Right Side Open Large 1⅜" x 4¾" (35mm x 121mm)  
038052-ANG Right Side Open Large Angled 1⅜" x 4¾" (35mm x 121mm)  
038051 Left Side Open Medium 1⅜" x 4" (35mm x 102mm)  
038051-ANG Left Side Open Medium Angled 1⅜" x 4" (35mm x 102mm)  
038053 Left Side Open Large 1⅜" x 4¾" (35mm x 121mm)  
038053-ANG Left Side Open Large Angled 1⅜" x 4¾" (35mm x 121mm)



### Collins Speculum Closed Tube

038047 Small 1¼" x 3¾" (32mm x 95mm)  
038048 Medium 1⅜" x 4" (35mm x 102mm)  
038049 Large 1⅝" x 4½" (41mm x 114mm)



### Four-Way Lateral Speculum

038093 Medium ⅞" x 4¼" (22mm x 108mm)  
038094 Large ⅞" x 5¼" (22mm x 133mm)



### Klopper Speculum

038054 1⅜" x 3½" (35mm x 89mm)



### Lateral Vaginal Wall Retractor

038060 Closed, 10" (254mm),  
Blade Size 1" x 2½" (25mm x 64mm)  
038061 Open ½" (13mm) 10" (254mm),  
Blade Size 1" x 2½" (25mm x 64mm)  
038062 Open 1" (25mm) 10" (254mm)  
Blade Size 1" x 2½" (25mm x 64mm)  
038063 Wide Open, 10" (254mm)  
Blade Size 1" x 2½" (25mm x 64mm)

## MedGyn Lletz Instruments - Blue Coated

All MedGyn Lletz instruments have a durable coating to insulate against transmission of electric current, ensuring the highest level of protection for patients and physicians.

### Lletz Kogan Endocervical Speculum

038057 Speculum 2-4mm, 11" (279mm)

038058 Speculum 4-8mm, 11" (279mm)

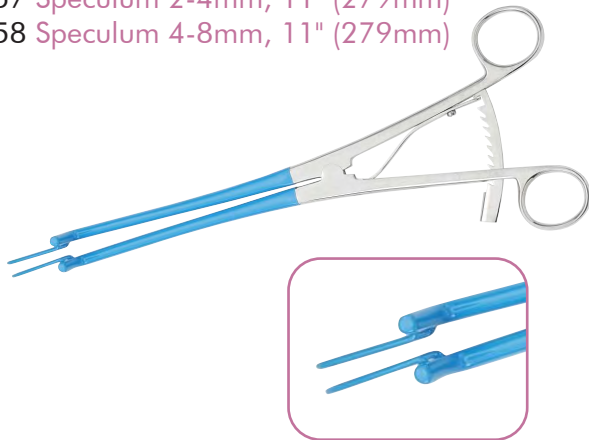

### Lletz Tenaculum

038070 Single-Tooth Tenaculum 9¾" (248mm)

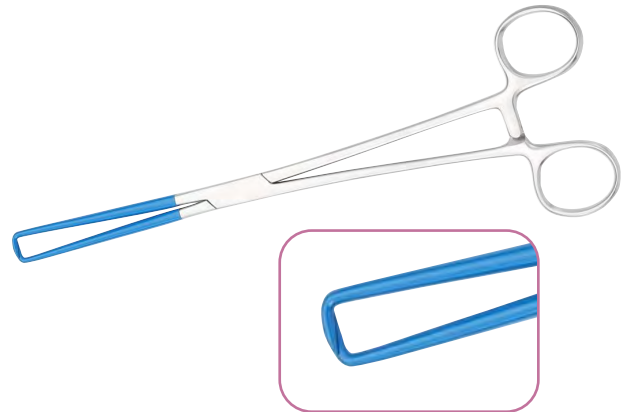

### Lletz Tenaculum Hook

038080 Emmet Tenaculum 9" (229mm)

038081 Iris Tenaculum Hook 9" (229mm)

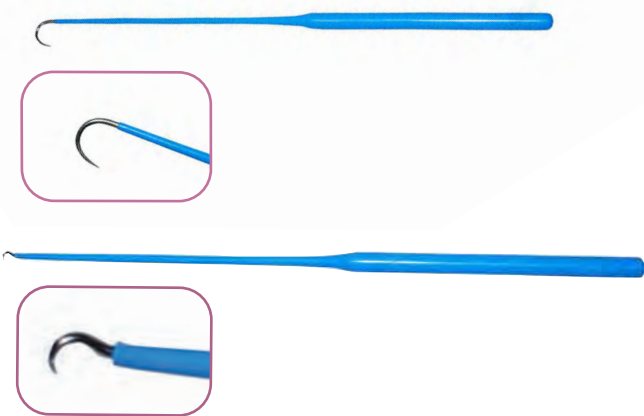

### Lletz Dressing Forceps

038082 Lletz Dressing Forceps Small 8" (203mm)

038092 Lletz Dressing Forceps Large 10" (254mm)

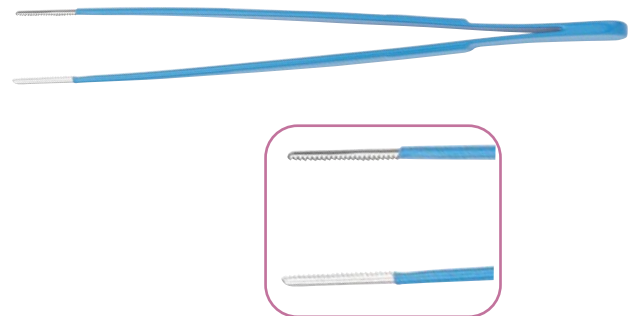

### Lletz Tissue Forceps

038090 Lletz Tissue Forceps Small 8" (203mm)

038091 Lletz Tissue Forceps Large 10" (254mm)

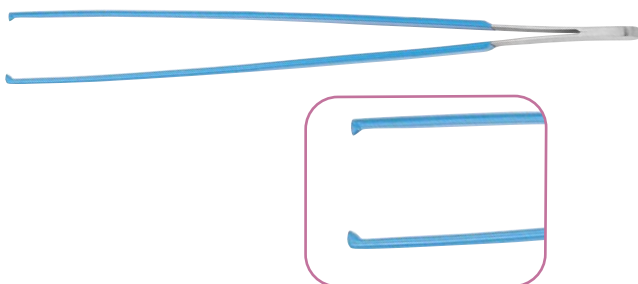

### Lletz Foerster Forceps

038071 Lletz Foerster Forceps - Straight 9½" (241mm)

038072 Lletz Foerster Forceps - Curved 9½" (241mm)



## MedGyn Endoscopic (Hysteroscopic) Cannula

MedGyn's Endoscopic (Hysteroscopic) Cannula is a single-use cannula for uterine observation pre- and post-surgery and is both diagnostic and therapeutic.

- Sterile, single-use, highly-durable lightweight, water resistant 6mm cannula
- Provides viewing of entire uterine cavity
- Anatomical curve cannula with dual, functions fluid infusion and suction
- Cannula has connections for light source and 8" monitor or laptop

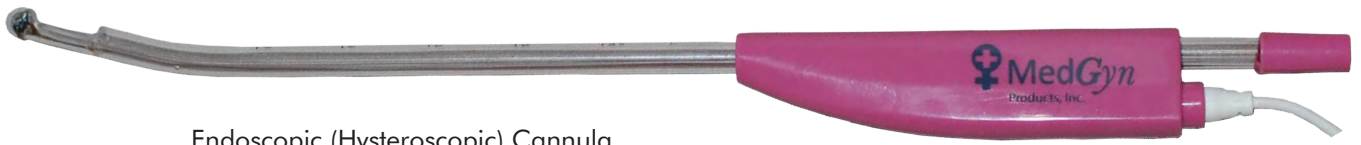

Endoscopic (Hysteroscopic) Cannula



Image Capture Software with Laptop



018145 MedGyn Endoscopic (Hysteroscopic) Cannula

018148 MedGyn Endoscopic (Hysteroscopic) Cannula Image Capture Software with Laptop

018149 MedGyn Endoscopic (Hysteroscopic) Cannula Image Capture Software

## MedGyn Fetal Monitors – "F" Series

MedGyn's F6 & F9 Fetal and Maternal Monitor series combine simultaneous mother and baby monitoring. These monitors offer powerful patient information management and centralized monitoring system compatibility with a color display.



F6 Fetal Monitor

- 10.2" foldable wide color screen
- 24-hour CTG storage
- Built-in thermal array printer
- Data management software for real-time data transmission to PC
- Intrapartum monitoring (DECG/IUP) (Optional)
- The F6 Express offers the same superior features as the F6 System but with maternal monitoring included

017118 MedGyn F6 Fetal Monitor (FM10)

017119 MedGyn F6 Fetal Monitor (FM10) Twin FHR

017120 MedGyn F6 Express Fetal Monitor (FM10)

- The F9 Fetal Monitor offers the same superior features as the F6 Fetal Monitor plus a foldable 12" color screen

017122 MedGyn F9 Fetal Monitor

017123 MedGyn F9 Express Fetal Monitor



F9 Fetal Monitor

### Fetal Monitor Accessories

017105 Strap for Fetal Monitor F6

017106 Battery for Fetal Monitor F6

017191 Recording Paper for Fetal Monitor F6

017192 Recording Paper for Fetal Monitor F9

017125 Fetal Monitor Stand (Adjustable with Rolling Base)

## MedGyn Ultrasonic Pocket Doppler

MedGyn Pocket Doppler combines reliable and accurate detection with easy-to-use, light-weight design. Available with rechargeable batteries and probe frequency options.

- Easy-to-read, back-lit LCD display
- Built-in recorder
- Accurate FHR detection with sound
- Automatic and manual FHR counting
- Interchangeable waterproof probes

017101 Ultrasonic Pocket Doppler with 2MHz Probe

017126 Ultrasonic Pocket Doppler with 3MHz Probe

017102 Ultrasonic Pocket Doppler with 2MHz Probe Rechargeable

017127 Ultrasonic Pocket Doppler with 3MHz Probe Rechargeable

### Ultrasonic Pocket Doppler Accessories

017128 2MHz Probe

017129 3MHz Probe

017130 4 MHz Probe

017132 5 MHz Probe

017131 8 MHz Probe

017100 MedGyn Ultrasonic Pocket Doppler (2MHz Probe)



Ultrasonic Pocket Doppler



MedGyn Ultrasonic Pocket Doppler

## MedGyn Ultrasonic Table-Top Doppler

MedGyn Table-Top Dopplers are innovative additions to our Doppler category in a portable, light-weight package. Available in both wireless/infrared and wired models.



SD5 Table-Top Doppler (Wired)



SD6 Table-Top Doppler (Wireless)

- Easy-to-read, back-lit LCD display
- Built-in recorder
- Accurate FHR calculation
- Portable lightweight design

017150 SD5 Table-Top Doppler with 2MHz probe, wired

017151 SD6 Table-Top Doppler with 2MHz probe, wireless

### Ultrasonic Table-Top Doppler Accessories

017155 2MHz Probe, Wired for SD5

017157 3MHz Probe, Wired for SD5

017156 2MHz Probe, Wireless for SD6

017158 3MHz Probe, Wireless for SD6

017159 Carry Bag for SD5/SD6

017160 Rolling Stand for SD5/SD6

017199 Doppler Gel 8oz

## Eco 3 Ultrasound

- 12" LED Monitor, 2 Probe Connectors, 3.5MHz Convex Probe
- Ergonomic Shape
- USB Connection
- THI (Tissue-Harmonic Imaging)
- SRA (Speckle-Reduction Algorithm)



015090 Eco 3 Ultrasound System

## Q5 Color Ultrasounds



- Q5: 15" LCD Monitor, 2 Probe Connectors, Convex and Linear Probes
- Double-Phase Digital Beam Forming (DPDBF)
- Tissue-Harmonic Imaging (THI) on all probes
- Speckle-Reduction Algorithm (SRA)
- Memory Storage via 2 USB Ports
- Built-in Software with Measurement and Reporting Functions

### Eco3 Ultrasound Accessories

- 015091 3.5MHz Convex Probe C3-A for Eco-3
- 015092 5.3 - 10.0 MHz Linear Probe L7M-A for Eco-3
- 015093 5.3 - 11.0 MHz Linear Probe L7S-A for Eco-3
- 015094 3.0MHz Phased Array Probe P3-A for Eco-3
- 015095 6.0MHz Trans-vaginal Probe V6-A for Eco-3
- 015096 7.5MHz Trans-rectal Probe R7-A for Eco-3
  
- 015097 6.0MHz Micro-convex Probe ( Pediatrics) MC6-A for Eco-3
- 015098 3.0MHz Micro-convex Probe MC3-A for Eco-3
- 015099 5.0MHz Micro-convex Probe MC5V-A for Eco-3
- 015100 DICOM for Eco-3
  
- 015084 4D Complete Package (Includes: 4.0 MHz 4D Volume Probe, 4D Motor Board , 4D Software)
- 015083 DICOM 3.0

### Q5 Ultrasound Accessories

- 015076 3.5 MHz Convex Probe
- 015077 7.5 MHz Linear Probe
- 015078 6.0 MHz Trans-vaginal Probe
- 015079 7.0 MHz Trans-vaginal Probe (180°)
- 015080 3.0 MHz Micro-convex Probe (adult cardiac)
- 015081 5.0 MHz Micro-convex Probe
- 015082 6.0 MHz Pediatric Micro-convex Probe

## Senator Vacuum Pump

Senator Vacuum Pump is made of high-quality components and with Swiss mechanical precision to guarantee excellent functionality. The Senator Vacuum Pump is ideal for removal of secretions, vacuum extractions, uterine suction and for pleural drainage.



- Suction capacity of 30 L/min
- Suction strength can be adjusted continuously and precisely
- Compact and user-friendly pump with large, integrated recessed grip
- Reliable 3-guard protective system with float levers integrated in bottle lids and hydrophobic bacterial filter

016100 [Senator Vacuum Pump \(Accessories and Trolley Sold Separately\)](#)

016150 [Senator Vacuum Pump System \(Includes Footswitch, Trolley, 2 Bottles and Bottle Holder\)](#)

## MedGyn MVP-100 Vacuum Pump

MedGyn MVP-100 Vacuum Pump is designed for safety and convenience. It features a push-switch linked directly to the pump and a trap bottle to control overflow.

- Applied oil-less piston vacuum pump
- Two collection bottles of 3,000 cc each
- Built-in anti-overflow device
- Push-switch (red button) linked directly to pump for ease of checking pump status
- Control low-voltage for user safety (under DC 12v)

016155 [MedGyn MVP-100: Vacuum Pump \(Includes Foot Switch, Collection Bottle\)](#)



## MedGyn Portable Vacuum Pump



- Oil-less piston requiring no lubrication and no maintenance
- 1000 mL autoclavable collection jar
- 12V rechargeable battery for two hours of operation

016156 [MedGyn Portable Vacuum Pump](#)



## MedGyn LED-100 Examination

MedGyn LED-100 Examination Lamp is used to assist in performing clinical and gynecological exams. The Lamp has a flexible, chrome-plated, top base with four casters for excellent maneuverability and stability. The LED-100 provides three times better light output than standard lamps with exceptional longevity and brightness

- Highly flexible LED light is easy to maneuver
- True tissue color rendition and pinpoint accuracy
- Power dual voltage 110V or 240V, 60/50Hz
- Illuminance of 20,000 lux (Distance of 50 cm)
- Minimum expected life of LED is 35,000 hours
- Net weight: 5 kg (10.2 lb)
- Variable height of 110cm and 150 cm ( 95.5lb x 130lb)
- Electrical Standards: NBR-IEC 60.601-1 and NBR-IEC 60.601-1-2

**010551** MedGyn LED-100 Examination Lamp  
(Includes Rolling base with 4 Casters)

## MedGyn GET-100 Examination Chair

MedGyn GET-100 Examination Chair is ergonomically designed for ease-of-use and patient comfort.



- Includes: Foot switch, Knee Clutch, Arm Rests, Screen Frame, Drain Tray
- Wide-range operation
- Heavy-duty with fiber-reinforced plastic base and aluminum top
- Side control panel with one-touch position memory and seat-warming control
- Chair can be operated in 3 directions (front, left, and right) by wireless control footswitch

**010550** MedGyn GET-100 Examination Chair

## MedGyn Mini-Microscope

MedGyn Mini-Microscope is a high-magnification, illuminated microscope designed for cytological review of cervical or endometrial cells.

- Compact design
- Up to 60x magnification
- Linear Field > 4mm
- Working distance 15 – 18mm



**017020** MedGyn Mini-Microscope  
**017025** Biolux-CXB Microscope Large



MedGyn LED-100 Examination Lamp



## MedGyn Endosampler™

Utilized for sampling of endometrial tissue, the unique design of the MedGyn Endosampler™ and Endosampler II™ allows for superior accuracy and a more reliable sample than traditional endometrial sample devices. The Endosampler II™ is available with two holes for easier and more comfortable suction.

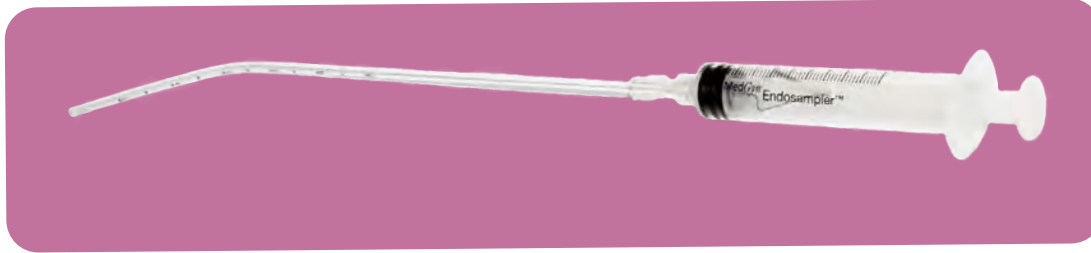

Endosampler™



Endosampler II™

- Includes 3mm curette & 10cc syringe with lock-spring mechanism
- Highly-visible, graduated markings on curette
- Semi-rigid curette allows for easier insertion and injection of saline or contrast
- Curved design for easier manipulation
- Back-flow prevented by syringe lock-spring mechanism
- Sharper slot at curette tip for better sampling
- “Closed” system prevents sample contamination

022720 MedGyn Endosampler™ (25/Box)  
022722 MedGyn Endosampler II™ (25/Box)

## MedGyn Pipette™

The MedGyn Pipette™, Pipette II™ and Pipette IV™ are unique, sterile, disposable cannulas for sampling the endometrium.



- Semi-rigid, tapered cannula for easy insertion
- Flexible enough to facilitate collection of tissue from all areas of the uterus
- Tip design minimizes risk of perforation
- Convenient for routine gynecologic use



Pipette™



Pipette II™



Pipette IV™

022721 MedGyn Pipette 3.1mm O.D. (25/Box)  
022734 MedGyn Pipette II 3.1mm O.D. (25/Box)  
022730 MedGyn Pipette IV 3.1mm O.D. (25/Box)

## MedGyn Pap Smear Devices

The MedGyn Cell Sweep® pap smear device simultaneously samples both the endocervix and ectocervix eliminating the need for both a Cytobrush and a Spatula.



- Allows for optimal cell harvesting and cell transferring
- Dual sampling of endo and ectocervix and separation of cells in one-slide technique
- Minimizes false negatives
- Minimizes red blood cells and blood artifacts

022362 MedGyn Cell Sweep® Slide Holder (100/Pack)

022361 MedGyn Cell Sweep® Non-Sterile (100/Pack)

022361K MedGyn Cell Sweep® Non-Sterile with Kit (Slide and Slide Holder) (100/Pack)

022363 MedGyn Cell Sweep® Sterile (100/Pack)

022363K MedGyn Cell Sweep® Sterile with Kit (Slide and Slide Holder) (100/Pack)

## MedGyn Cytobrush and Pap

Standard devices for one of the most frequently performed gynecology procedures.



022710 MedGyn Cytobrush (100/Box)

022364 MedGyn Pap Cell (50/Box)

## MedGyn Mucous Sampler

The MedGyn Mucous Sampler is a single-use, sterile, endocervical aspirator.



- The device consists of a 23 cm long, clear, flexible polypropylene tube.
- The distal tip of the device is rounded with a circular opening of 2.2 mm diameter for the specimen to be aspirated into the sheath lumen.

022729 MedGyn Disposable Mucous Sampler (25/Pack)

## MedGyn Endocervical Curette

The MedGyn Endocervical Curette provides an efficient sampling of the cervical canal to test for abnormal, precancerous conditions, or cervical cancer.



Kevorkian-Young  
with Basket

- The Kevorkian-Young endocervical curette is a sterile, single-use device with a basket and a square tip.

022732 MedGyn Disposable Endocervical Curette (25/Box)

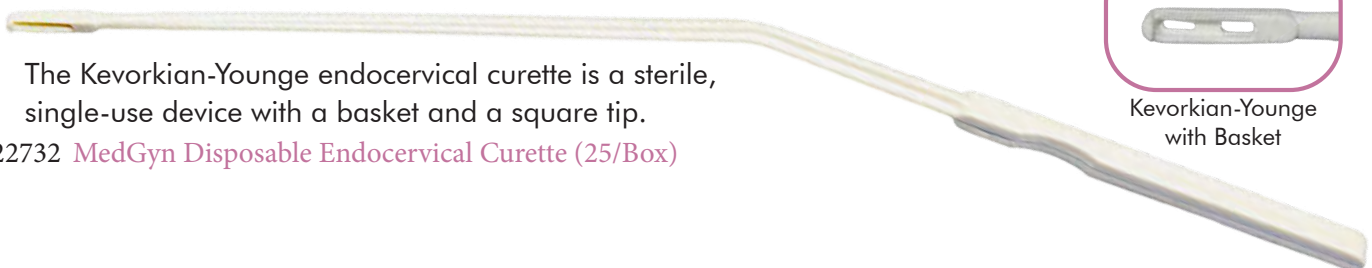

## MedGyn IUI Catheters

MedGyn Insemination Catheter is a sterile, flexible catheter designed for use in intrauterine insemination. Tip of catheter is rounded and beveled for patient comfort.



022723 MedGyn Intrauterine Insemination Catheter - Regular/Straight (25/Box)

022724 MedGyn Intrauterine Insemination Catheter - Mini (25/Box)

022725 MedGyn Intrauterine Insemination Catheter - Curved (25/Box)



Regular



Mini



Curved

## MedGyn HSG Catheters

MedGyn HSG Catheter is used to inject contrast media or saline into the uterus and fallopian tubes for hysterosalpingography and sonohysterography procedures. It has a latex-free balloon catheter with a rigid insertion sheath.



022726 MedGyn HSG Catheters - 5Fr (10/Box)

022728 MedGyn HSG Catheters - 7Fr (10/Box)

## MedGyn Uterine Sounds

MedGyn Disposable Uterine Sounds are made of malleable plastic with centimeter graduations for accurate measurement of uterine cavity.

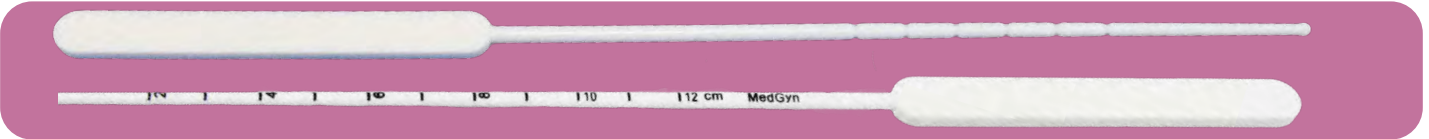

020250 MedGyn Disposable Uterine Sounds 3mm O.D. (25/Box)

020250BM MedGyn Disposable Uterine Sounds O.D. 3mm 10" Length with Marking (25/Box)

## MedGyn LED Speculum

MedGyn LED Speculum has a cordless LED light to improve visualization of the exam area.



Large



Medium



Small

020227 MedGyn Graves/Pederson LED Large (100/Box)

020226 MedGyn Graves/Pederson w/ LED Medium (100/Box)

020225 MedGyn Graves/Pederson w/ LED Small (100/Box)

020225S MedGyn Sterile Graves/Pederson w/ LED Small (100/Box)

020226S MedGyn Sterile Graves/Pederson w/ LED Medium (100/Box)

020227S MedGyn Sterile Graves/Pederson w/ LED Large (100/Box)

## MedGyn Vaginal Speculum

MedGyn Disposable Speculum is available in both Graves and Pederson styles and easily locks in a variety of positions to reduce examination time.



Large



Medium



Small

020205 MedGyn Disposable Graves Large (100/Box)

020204 MedGyn Disposable Graves Medium (100/Box)

020201 MedGyn Disposable Pederson Small (100/Box)

## MedGyn Pregnancy Test

MedGyn One-Step Pregnancy Test Kit is an easy-to-use clinical pregnancy test that delivers fast and accurate results. Our tests have built-in test controls and highly visible color.



022704 MedGyn Pregnancy HCG Cassette Urine Test (25/Box)

022705 MedGyn Pregnancy HCG Combo Urine/Serum Test (25/Box)

022706 MedGyn Pregnancy HCG Dipstick Urine Test (25/Box)

## MedGyn Vacuum Assisted Delivery Cups

MedGyn Vacuum Delivery Cups offer optimal adhesion to ensure proper vacuum levels

020322 MedGyn Vacuum Delivery Cups 50mm with Release Valve

020323 MedGyn Vacuum Delivery Cups 60mm with Release Valve

020316 MedGyn Vacuum Delivery Cups 70mm with Release Valve

## MedGyn HVP-100 Hand-Held Vacuum Delivery Pump

MedGyn Hand-Held Vacuum Delivery Pump may be used to safely assist medical personnel during vaginal deliveries.



020320 Vacuum Delivery Cup 50mm

020321 Vacuum Delivery Cup 60mm

016160 MedGyn HVP-100 Hand-Held Vacuum Delivery Pump

## MedGyn Amnio Hook

MedGyn Amnio Hook is designed to perforate the amniotic membrane with a rigid talon tip.



020301 MedGyn Disposable Amnio Hook (50/Pack)

## MedGyn Balloon Catheter

MedGyn Postpartum Balloon Catheter is a disposable, multiple lumen catheter attached to an inflatable balloon system designed to provide tamponade for controlling hemorrhage from the uterus and vagina.



022703 MedGyn Balloon Catheter



Release Valve

## MedGyn Umbilical Cord

MedGyn Umbilical Cord Clamp has grooved clamping and lock to secure the umbilical cord prior to cutting.



020302 MedGyn Disposable Umbilical Cord Clamp (100/Pack)

## MedGyn Laminaria

Laminaria (type of hygroscopic dilator) is a 100% natural sterile cervical dilator made from a sea-grown plant containing no synthetic materials. Safely utilized for over a century, Laminaria provides gentle, gradual dilation. After harvesting, the plant is dehydrated. Once inserted into the cervical canal, Laminaria absorbs liquid, swelling to several times its initial dried diameter, gently dilating the cervix.

### Standard, approximate length, 60mm

- 021002 2mm Extra Small/Extra Thin (25/Box)
- 021003 3mm Small (25/Box)
- 021004 4mm Medium (25/Box)
- 021005 5mm Large/Thick (25/Box)
- 021006 6mm Extra Large/Extra Thick (25/Box)
- 021008 8mm Jumbo (25/Box)
- 021010 10mm Extra Jumbo (25/Box)



### Extra Long, approximate length, 70mm

- 021014 4mm Long 70mm (25/Box)
- 021015 5mm Long 70mm (25/Box)
- 021016 6mm Long 70mm (25/Box)
- 021018 8mm Long 70mm (25/Box)

- 021003L Laminaria #3 Long-String
- 021004L Laminaria #4 Long-String
- 021005L Laminaria #5 Long-String
- 021006L Laminaria #6 Long-String
- 021008L Laminaria #8 Long-String

### With buttons to prevent over-insertion

- 021022 2mm Extra Small with Buttons (12/Box)
- 021023 3mm Small with Buttons (12/Box)
- 021024 4mm Medium with Buttons (12/Box)
- 021025 5mm Large with Buttons (12/Box)
- 021026 6mm Extra Large with Buttons (12/Box)

### McMahon Laminaria Inserter

- 031202 McMahon Laminaria Inserter

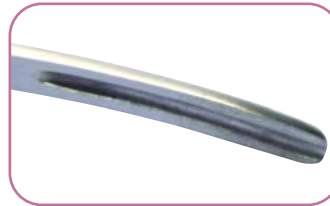

### Laminaria Inserter

- 031201 MedGyn Laminaria Inserter



## MedGyn Aspiration Kits

MedGyn Aspiration Kit and Aspiration Kit IV are effective devices for simultaneous endometrial curettage and aspiration.

- 022514 MedGyn Aspiration Kit with 4mm Cannula-Curette (10/Pack)
- 022515 MedGyn Aspiration Kit with 5mm Cannula-Curette (10/Pack)
- 022516 MedGyn Aspiration Kit with 6mm Cannula-Curette (10/Pack)
- 022517 MedGyn Aspiration Kit with 7mm Cannula-Curette (10/Pack)
- 022511 MedGyn Aspiration Kit IV with 4mm, 5mm, 6mm and 7mm Cannula-Curette (10/Pack)



## MedGyn Aspiration Kit Double Valve

MedGyn Aspiration Kit Double Valve is used for uterine aspiration/uterine evacuation in obstetrics and gynecologic procedures. The device fits the MedGyn Flexible Karman Curettes and a wide variety of MedGyn Rigid and Straight Curettes.

- 022526 MedGyn Aspiration Kit Double Valve



## MedGyn Vacuum Cannulas-Curettes

MedGyn offers a complete line of high-quality, disposable vacuum cannulas-curettes in the industry. Available in Rigid Curved, Rigid Straight, Flexible and Flexible Karman options, our cannulas-curettes are individually packaged and sterilized.

### Rigid Curved Cannula-Curette

022106 6mm (50/Pack)	022113 13mm - 3/8" Base (25/Pack)
022107 7mm (50/Pack)	022114 14mm - 1/2" Base (25/Pack)
022108 8mm (50/Pack)	022144 14mm - 1/2" Base w/Adapter(25/Pack)
022109 9mm (50/Pack)	022145 14mm - 3/8" Base (25/Pack)
022110 10mm (50/Pack)	022115 15mm - 1/2" Base (25/Pack)
022111 11mm (50/Pack)	022116 16mm - 1/2" Base (25/Pack)
022112 12mm (50/Pack)	

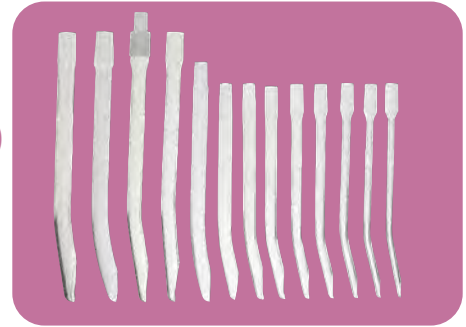

### Rigid Straight Cannula-Curette

022206 6mm (50/Pack)
022207 7mm (50/Pack)
022208 8mm (50/Pack)
022209 9mm (50/Pack)
022210 10mm (50/Pack)
022211 11mm (50/Pack)
022212 12mm (50/Pack)



### Flexible/Karman Cannula-Curette

022213 13mm - 3/8" Base (25/Pack)
022214 14mm - 1/2" Base (25/Pack)
022244 14mm - 1/2" Base w/Adapter (25/Pack)
022245 14mm - 3/8" Base (25/Pack)
022215 15mm - 1/2" Base (25/Pack)
022216 16mm - 1/2" Base (25/Pack)



### Flexible Cannula-Curette with Dual Port Design

022004 4mm (50/Pack)
022005 5mm (50/Pack)
022006 6mm (50/Pack)
022007 7mm (50/Pack)
022008 8mm (50/Pack)
022009 9mm (50/Pack)
022010 10mm (50/Pack)
022011 11mm (50/Pack)
022012 12mm (50/Pack)

### Flexible/Karman Cannula-Curette

022004K 4mm (10/Pack)
022005K 5mm (10/Pack)
022006K 6mm (10/Pack)
022007K 7mm (10/Pack)
022008K 8mm (10/Pack)
022009K 9mm (10/Pack)
022010K 10mm (10/Pack)
022011K 11mm (10/Pack)



## MedGyn Collection Sets, Collection Jars and Bags

MedGyn Disposable Collection Sets include 6' tubing (either 3/8" or 1/2" I.D.) attached to a control handle with slip-ring for finger-tip vacuum control. The Collection Sets are individually packaged and sterile.



3/8" Collection Set with Handle & 6' tubing attached

### Metal Swivel Handles

Stainless steel, autoclavable, with slip-ring control

- 022450 3/8" Handle for Currettes up to 14mm with small base
- 022451 1/2" Handle for 14mm, 15mm & 16mm Currettes
- 022340 Stainless Steel 3/8" Female Fitting
- 022341 Stainless Steel 3/8" Male Fitting
- 022343 Stainless Steel 1/2" Male Fitting
- 022352 Stainless Steel 3/8" Handle Extender
- 022353 Stainless Steel 1/2" Handle Extender



022450 Stainless Steel Handle



022352 Handle Extender 3/8"



022343 1/2" Male Fitting



022340 Female Fitting



022341 3/8" Male Fitting

### Collection Sets & Bottles

- 022310 3/8" Collection Set with Handle
- 022310NS 3/8" Collection Set w/Handle & Adapter (Non-Sterile)
- 022310-WO 3/8" Collection Set with Handle (Without Adapter, Sterile) (50/Pack)
- 022310-50 3/8" Collection Set with Handle (50/Pack)
- 022314 3/8" Collection Set x 8 Ft with Handle & Adaptor
- 022312 1/2" Collection Set with Handle & Adapter
- 022312-25 1/2" Collection Set with Handle (25/Pack)
- 022312NS 1/2" Collection Set w/Handle & Adapter (Non-Sterile)
- 022331 3/8" Disp. Collection Jar - with Cap (10/Box)
- 022332 1/2" Disp. Collection Jar - with Cap (10/Box)
- 003984-901 3/8" Disposable Collection Jar with Cap & Tissue Trap (10/Box)
- 022323 Disp. Tops Large Non-Conductive (10/Box)
- 022324 Disp. Tops Small Non-Conductive (10/Box)

### Accessories

- 022316-3/8-6 Tubing 3/8" Precut to 6'
- 022311 Tubing 3/8", Custom Cut Per Foot
- 022316-1/2-6 Tubing 1/2" Precut to 6'
- 022313 Tubing 1/2", Custom Cut Per Foot
- 022317 Tubing 16" Connector
- 022318 Tubing 20" Connector
- 022317-ADAP Tube Fitting - Male 3/8" Plastic
- 022317-INT Tube - Interconnecting with Adapter (10/Box)
- 022350 Plastic Adapter for 1/2" Base Currettes (Sterile)
- 022351 Plastic Adapter for 1/2" Base Currettes (Non-Sterile)
- O-RING-FAD 3/8" O Ring for Female Adapter (10/Pack)
- 022320 Disposable Filter Assembly (10/Box)
- T.TRAP/ST Safe-Touch Tissue Trap (10/Box)
- ADAP-REDC 1/2" to 3/8" Adapter for Aspiration Handle (For Small Curette) (10/Box)
- 022354 3/8" to 1/2" Adapter for Aspiration Handle (For Large Curette)

### Permeable Gauze Sacks

Gauze collection sack easily attaches to collection canister for simple and efficient separation of tissue from aspirated fluid.

- 022460 Gauze Sacks Tissue Trap (10/Box)
- O-RING3/8 O Ring for 3/8" Sack (10/Box)
- O-RING1/2 O Ring for 1/2" Sack (10/Pack)



## MedGyn IUD Kit

This sterile, single use kit contains everything needed to insert or remove an IUD (intrauterine device).



We have included the following products:  
 022365-M IUDKit consisting of Metal Cherron Forceps, Pozzy Forceps, Long Littauer Scissors, Uterine Sound (25/box)



022365 MedGyn IUD Kit consists of Cherron Forceps, Pozzy Forceps, Long Littauer Scissors, Uterine Sound (25/Box)

022711 MedGyn Disposable Pozzy Forceps (25/Box)

022712 MedGyn Disposable Littaur Scissor (25/Box)

022713 MedGyn Disposable Cherron Forceps (25/Box)

## MedGyn's IUD Retriever

MedGyn's IUD Retriever is designed to assist in the removal of the intrauterine device from the uterus.



022366 Disposable IUD Retriever (25/Box)

## MedGyn Uterine Manipulator

This device is used for laparoscopic tubal occlusion, diagnostic laparoscopy, mini laparotomy, salpingoplasty and fertility exams. Pear-shaped balloon provides optimal hold and a perfect seal at the internal OS. Smaller cannula size allows for easier insertion and comfort.



022701 MedGyn Uterine Manipulator(12/Box)

## MedGyn Os Finders

Ideal for cervical dilation, uterine sounding or other intrauterine procedures. Made of malleable plastic and packaged individually sterile.



022731 MedGyn Disposable Os Finder (50/Pack)

022731-12 MedGyn Disposable Os Finder

## MedGyn Word Bartholin's Catheter

For use following an incision and drainage of a Bartholin's cyst or abscess. Catheter kit includes balloon catheter, syringe for balloon inflation and scalpel.



022719 MedGyn Word Bartholin's Catheter (6/Box)

## MedGyn Needle Extender

An effective means of extending ordinary hypodermic needles when longer needles are required.



022600 MedGyn Disposable Needle Extender

## MedGyn Single-Use Forceps



029701-D Tischler Biopsy Single-Use Forceps (10/Pack)



029702-D Baby Tischler Biopsy Single-Use Forceps (10/Pack)



029703-D Kevorkian-Younger Biopsy Single-Use Forceps (10/Pack)

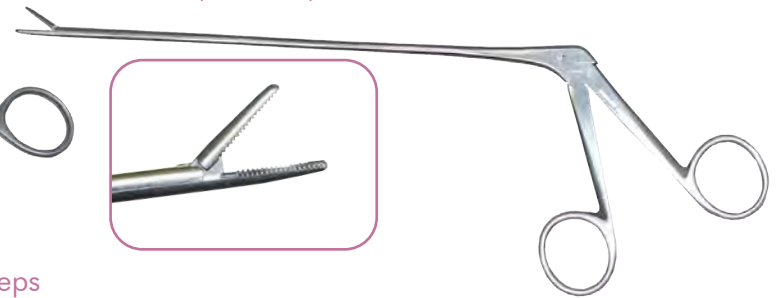

030112-D Alligator Single-Use Forceps (10/Pack)

## MedGyn Rotating Biopsy Forceps

MedGyn's Rotating Biopsy Punch is our latest single-use device made of stainless steel to sample cervical tissue.



030100-D Disposable Rotating Biopsy Forceps

## MedGyn's Disposable Derma (Keyes Biopsy) Punch

MedGyn's latest products include a disposable derma (keyes biopsy) punch made of quality stainless steel and a ribbed sturdy handle for the ejection of lodged specimen.



- 022727-1 Disposable Derma (Keyes Biopsy) Punch 1mm- STERILE
- 022727-2 Disposable Derma (Keyes Biopsy) Punch 2mm- STERILE
- 022727-3 Disposable Derma (Keyes Biopsy) Punch 3mm- STERILE
- 022727-4 Disposable Derma (Keyes Biopsy) Punch 4mm- STERILE
- 022727-5 Disposable Derma (Keyes Biopsy) Punch 5mm- STERILE

## MedGyn's Disposable Derma Curette



- 022797-3 Disposable Derma- Curette 3.0mm- STERILE
- 022797-4 Disposable Derma- Curette 4.0mm- STERILE
- 022797-7 Disposable Derma- Curette 7.0mm- STERILE

## MedGyn's Disposable Scalpel

MedGyn's latest products include disposable scalpels made of quality stainless steel blades with sturdy, non-slip plastic handles.



- 022798-11 Disposable Scalpel #11- STERILE
- 022798-15 Disposable Scalpel #15- STERILE

## MedGyn Monsel's Solution

Ferric Sub sulfate Solution 20% is an effective hemostatic solution for use after cervical biopsies.



- 022610 Monsel's Solution - 8mL bottles (12/Box)
- 022612 Monsel's Solution - 500 mL bottle

## Other

- 040065 Video Print Paper - 110mm x 20mm rolls (10/Box)

## MedGyn Silicone Pessaries

Pessaries are an effective tool for the non-surgical treatment of a variety of gynecologic problems. Commonly used for management of pelvic support defects, pessaries are also used to treat stress urinary incontinence. MedGyn offers an extensive line of quality medical-grade silicone pessaries and easy-to-use pessary fitting sets.

### MedGyn Pessary Case



051001 MedGyn Pessary Case (28 different pessaries including Ring Fitting Set)



### MedGyn Ring w/o Support

- 050017 Ring w/o Support #1 (51mm, 2in)
- 050018 Ring w/o Support #2 (57mm, 2.2in)
- 050019 Ring w/o Support #3 (62mm, 2.4in)
- 050020 Ring w/o Support #4 (70mm, 2.75in)
- 050021 Ring w/o Support #5 (74mm, 2.9in)
- 050022 Ring w/o Support #6 (82mm, 3.2in)
- 050023 Ring w/o Support #7 (89mm, 3.5in)
- 050024 Ring w/o Support #8 (96mm, 3.8in)
- 050025 Ring w/o Support #9 (102mm, 4in)

### MedGyn Ring with Support

- 050026 Ring w/ Support #1 (51mm, 2in)
- 050027 Ring w/ Support #2 (57mm, 2.2in)
- 050028 Ring w/ Support #3 (62mm, 2.4in)
- 050029 Ring w/ Support #4 (70mm, 2.75in)
- 050030 Ring w/ Support #5 (74mm, 2.9in)
- 050031 Ring w/ Support #6 (82mm, 3.2in)
- 050032 Ring w/ Support #7 (89mm, 3.5in)
- 050033 Ring w/ Support #8 (96mm, 3.8in)
- 050034 Ring w/ Support #9 (102mm, 4in)

### MedGyn Fitting Set

051000 Ring w/o Support Pessary Fitting Set of 6



051005 Ring w/ Support Pessary Fitting Set of 6



051006 Shatz Pessary Fitting Set of 6

### MedGyn Modified Cup w/ Drain

- 050210M Modified Cup #1 w/ Drain (65mm, 2.6in)
- 050211M Modified Cup #2 w/ Drain (70mm, 2.8in)
- 050212M Modified Cup #3 w/ Drain (65mm, 2.6in)
- 050213M Modified Cup #4 w/ Drain (70mm, 2.8in)
- 050214M Modified Cup #5 w/ Drain (65mm, 2.6in)
- 050215M Modified Cup #6 w/ Drain (70mm, 2.8in)



### MedGyn Modified Cup w/o Drain

- 050191M Modified Cup #1 w/o Drain (65mm, 2.6in)
- 050192M Modified Cup #2 w/o Drain (70mm, 2.8in)
- 050193M Modified Cup #3 w/o Drain (65mm, 2.6in)
- 050194M Modified Cup #4 w/o Drain (70mm, 2.8in)
- 050195M Modified Cup #5 w/o Drain (65mm, 2.6in)
- 050196M Modified Cup #6 w/o Drain (70mm, 2.8in)

## MedGyn Silicone Pessaries



### MedGyn Ring with Knob w/Support

- 050026K Ring w/ Knob - w/ Support #1 (51mm, 2in)
- 050027K Ring w/ Knob - w/ Support #2 (57mm, 2.2in)
- 050028K Ring w/ Knob - w/ Support #3 (63mm, 2.5in)
- 050029K Ring w/ Knob - w/ Support #4 (70mm, 2.8in)
- 050030K Ring w/ Knob - w/ Support #5 (76mm, 3in)
- 050031K Ring w/ Knob - w/ Support #6 (83mm, 3.3in)
- 050032K Ring w/ Knob - w/ Support #7 (89mm, 3.5in)

### MedGyn Ring w/ Knob w/o Support

- 050017K Ring w/ Knob - w/o Support #1 (51mm, 2in)
- 050018K Ring w/ Knob - w/o Support #2 (57mm, 2.2in)
- 050019K Ring w/ Knob - w/o Support #3 (63mm, 2.5in)
- 050020K Ring w/ Knob - w/o Support #4 (70mm, 2.8in)
- 050021K Ring w/ Knob - w/o Support #5 (76mm, 3in)
- 050022K Ring w/ Knob - w/o Support #6 (83mm, 3.3in)
- 050023K Ring w/ Knob - w/o Support #7 (89mm, 3.5in)



### MedGyn Gellhorn with Drain

- 050155 Gellhorn w/ Drain #1 (44mm, 1.7in)
- 050156 Gellhorn w/ Drain #2 (51mm, 2in)
- 050157 Gellhorn w/ Drain #3 (57mm, 2.2in)
- 050158 Gellhorn w/ Drain #4 (63mm, 2.5in)
- 050159 Gellhorn w/ Drain #5 (70mm, 2.8in)
- 050160 Gellhorn w/ Drain #6 (76mm, 3in)
- 050161 Gellhorn w/ Drain #7 (82mm, 3.2in)
- 050162 Gellhorn w/ Drain #8 (89mm, 3.5in)



### MedGyn Gellhorn Short Stem

Stem Height 28 mm, 1.1 in

- 050155S Gellhorn Short Stem #1 (44mm, 1.7in)
- 050156S Gellhorn Short Stem #2 (51mm, 2in)
- 050157S Gellhorn Short Stem #3 (57mm, 2.2in)
- 050158S Gellhorn Short Stem #4 (63mm, 2.5in)
- 050159S Gellhorn Short Stem #5 (70mm, 2.8in)
- 050160S Gellhorn Short Stem #6 (76mm, 3in)
- 050161S Gellhorn Short Stem #7 (82mm, 3.2in)
- 050162S Gellhorn Short Stem #8 (89mm, 3.5in)



### MedGyn Donut

- 050010 Donut #0 (51mm, 2in)
- 050011 Donut #1 (57mm, 2.2in)
- 050012 Donut #2 (64mm, 2.5in)
- 050013 Donut #3 (69mm, 2.7in)
- 050014 Donut #4 (76mm, 3in)
- 050015 Donut #5 (82mm, 3.2in)
- 050016 Donut #6 (88mm, 3.5in)
- 050199 Donut #7 (95mm, 3.7in)

## MedGyn Silicone Pessaries



### MedGyn Shaatz with Drain

- 050120 Shaatz w/ Drain #0 (38mm, 1.5in)
- 050121 Shaatz w/ Drain #1 (44mm, 1.75in)
- 050122 Shaatz w/ Drain #2 (51mm, 2in)
- 050123 Shaatz w/ Drain #3 (57mm, 2.2in)
- 050124 Shaatz w/ Drain #4 (64mm, 2.5in)
- 050125 Shaatz w/ Drain #5 (70mm, 2.8in)
- 050126 Shaatz w/ Drain #6 (76mm, 3in)
- 050127 Shaatz w/ Drain #7 (82mm, 3.2in)
- 050128 Shaatz w/ Drain #8 (88mm, 3.5in)



### MedGyn Cube w/o Drain

- 050055 Cube w/o Drain #0 (25mm, 0.98in)
- 050056 Cube w/o Drain #1 (29mm, 1.1in)
- 050057 Cube w/o Drain #2 (32mm, 1.2in)
- 050058 Cube w/o Drain #3 (36mm, 1.4in)
- 050059 Cube w/o Drain #4 (40mm, 1.6in)
- 050060 Cube w/o Drain #5 (45mm, 1.8in)
- 050061 Cube w/o Drain #6 (49mm, 1.9in)
- 050062 Cube w/o Drain #7 (55mm, 2.2in)
- 050063 Cube w/o Drain #8 (63mm, 2.5in)
- 050064 Cube w/o Drain #9 (69mm, 2.7in)
- 050065 Cube w/o Drain #10 (74mm, 2.9in)



### MedGyn Cube with Drain

- 050066 Cube w/ Drain #0 (25mm, 0.98in)
- 050067 Cube w/ Drain #1 (29mm, 1.1in)
- 050068 Cube w/ Drain #2 (32mm, 1.2in)
- 050069 Cube w/ Drain #3 (36mm, 1.4in)
- 050070 Cube w/ Drain #4 (40mm, 1.6in)
- 050071 Cube w/ Drain #5 (45mm, 1.8in)
- 050072 Cube w/ Drain #6 (49mm, 1.9in)
- 050073 Cube w/ Drain #7 (55mm, 2.2in)
- 050074 Cube w/ Drain #8 (63mm, 2.5in)
- 050075 Cube w/ Drain #9 (69mm, 2.7in)
- 050076 Cube w/ Drain #10 (74mm, 2.9in)



### MedGyn Cup with Support

- 050171 Cup w/ Support #0 (48mm, 1.8in)
- 050172 Cup w/ Support #1 (52mm, 2in)
- 050173 Cup w/ Support #2 (57mm, 2.25in)
- 050174 Cup w/ Support #3 (63mm, 2.5in)
- 050175 Cup w/ Support #4 (68mm, 2.7in)
- 050176 Cup w/ Support #5 (73mm, 2.9in)
- 050177 Cup w/ Support #6 (77mm, 3in)
- 050178 Cup w/ Support #7 (82mm, 3.2in)

## MedGyn Silicone Pessaries

### MedGyn Cup w/o Support

- 050163 Cup w/o Support #0 (48mm, 1.8in)
- 050164 Cup w/o Support #1 (52mm, 2in)
- 050165 Cup w/o Support #2 (57mm, 2.25in)
- 050166 Cup w/o Support #3 (63mm, 2.5in)
- 050167 Cup w/o Support #4 (68mm, 2.7in)
- 050168 Cup w/o Support #5 (73mm, 2.9in)
- 050169 Cup w/o Support #6 (77mm, 3in)
- 050170 Cup w/o Support #7 (82mm, 3.2in)



### MedGyn Oval with Support

- 050111 Oval w/ Support #1 (51mm, 2in)
- 050112 Oval w/ Support #2 (57mm, 2.25in)
- 050113 Oval w/ Support #3 (64mm, 2.5in)
- 050114 Oval w/ Support #4 (69mm, 2.7in)
- 050115 Oval w/ Support #5 (76mm, 3in)
- 050116 Oval w/ Support #6 (83mm, 3.25in)
- 050117 Oval w/ Support #7 (89mm, 3.5 in)
- 050118 Oval w/ Support #8 (95mm, 3.75in)
- 050119 Oval w/ Support #9 (102mm, 4in)

### MedGyn Dish with Support

- 050137 Dish w/ Support #0 (50mm, 2in)
- 050138 Dish w/ Support #1 (55mm, 2.2in)
- 050139 Dish w/ Support #2 (60mm, 2.4in)
- 050140 Dish w/ Support #3 (63mm, 2.5in)
- 050141 Dish w/ Support #4 (68mm, 2.7in)
- 050142 Dish w/ Support #5 (73mm, 2.9in)
- 050143 Dish w/ Support #6 (80mm, 3.1in)
- 050144 Dish w/ Support #7 (85mm, 3.3in)



### MedGyn Oval w/o Support

- 050101 Oval w/o Support #1 (51mm, 2in)
- 050102 Oval w/o Support #2 (57mm, 2.25in)
- 050103 Oval w/o Support #3 (64mm, 2.5in)
- 050104 Oval w/o Support #4 (69mm, 2.7in)
- 050105 Oval w/o Support #5 (76mm, 3in)
- 050106 Oval w/o Support #6 (83mm, 3.25in)
- 050107 Oval w/o Support #7 (89mm, 3.5in)
- 050108 Oval w/o Support #8 (95mm, 3.75 in)
- 050109 Oval w/o Support #9 (102mm, 4in)

### MedGyn Dish w/o Support

- 050129 Dish w/o Support #0 (50mm, 2in)
- 050130 Dish w/o Support #1 (55mm, 2.2in)
- 050131 Dish w/o Support #2 (60mm, 2.4in)
- 050132 Dish w/o Support #3 (63mm, 2.5in)
- 050133 Dish w/o Support #4 (68mm, 2.7in)
- 050134 Dish w/o Support #5 (73mm, 2.9in)
- 050135 Dish w/o Support #6 (80mm, 3.1in)
- 050136 Dish w/o Support #7 (85mm, 3.3in)



## MedGyn Marland with Support

- 050084 Marland w/ Support #2 (57mm, 2.25in)
- 050085 Marland w/ Support #3 (63mm, 2.5in)
- 050086 Marland w/ Support #4 (70mm, 2.75in)
- 050087 Marland w/ Support #5 (76mm, 3in)
- 050088 Marland w/ Support #6 (83mm, 3.25in)
- 050089 Marland w/ Support #7 (89mm, 3.5in)
- 050090 Marland w/ Support #8 (95mm, 3.75in)

## Medgyn Marland w/o Support

- 050077 Marland w/o Support #2 (57mm, 2.25in)
- 050078 Marland w/o Support #3 (63mm, 2.5in)
- 050079 Marland w/o Support #4 (70mm, 2.75in)
- 050080 Marland w/o Support #5 (76mm, 3in)
- 050081 Marland w/o Support #6 (83mm, 3.25in)
- 050082 Marland w/o Support #7 (89mm, 3.5in)
- 050083 Marland w/o Support #8 (95mm, 3.75in)



## MedGyn Gehrung with Support

- 050145 Gehrung w/ Support #0 (50mm, 1.9in)
- 050146 Gehrung w/ Support #1 (55mm, 2.2in)
- 050147 Gehrung w/ Support #2 (60mm, 2.4in)
- 050148 Gehrung w/ Support #3 (65mm, 2.6in)
- 050149 Gehrung w/ Support #4 (70mm, 2.8in)
- 050150 Gehrung w/ Support #5 (75mm, 3in)
- 050151 Gehrung w/ Support #6 (80mm, 3.2in)
- 050152 Gehrung w/ Support #7 (85mm, 3.4in)
- 050153 Gehrung w/ Support #8 (90mm, 3.6in)

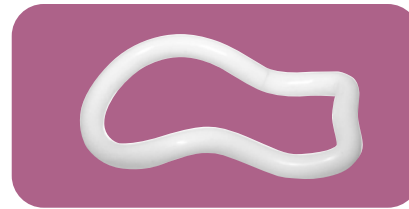

## MedGyn Hodge w/o Support

- 050035 Hodge w/o Support #0 (65mm, 2.6in)
- 050036 Hodge w/o Support #1 (70mm, 2.8in)
- 050037 Hodge w/o Support #2 (75mm, 3in)
- 050038 Hodge w/o Support #3 (80mm, 3.2in)
- 050039 Hodge w/o Support #4 (85mm, 3.4in)
- 050040 Hodge w/o Support #5 (90mm, 3.6in)
- 050041 Hodge w/o Support #6 (95mm, 3.8in)
- 050042 Hodge w/o Support #7 (100mm, 4in)
- 050043 Hodge w/o Support #8 (105mm, 4.2in)
- 050044 Hodge w/o Support #9 (110mm, 4.4in)



## MedGyn Hodge with Support

- 050045 Hodge w/ Support #0 (65mm, 2.6in)
- 050046 Hodge w/ Support #1 (70mm, 2.8in)
- 050047 Hodge w/ Support #2 (75mm, 3in)
- 050048 Hodge w/ Support #3 (80mm, 3.2in)
- 050049 Hodge w/ Support #4 (85mm, 3.4in)
- 050050 Hodge w/ Support #5 (90mm, 3.6in)
- 050051 Hodge w/ Support #6 (95mm, 3.8in)
- 050052 Hodge w/ Support #7 (100mm, 4in)
- 050053 Hodge w/ Support #8 (105mm, 4.2in)
- 050054 Hodge w/ Support #9 (110mm, 4.4in)

## Graves Speculum

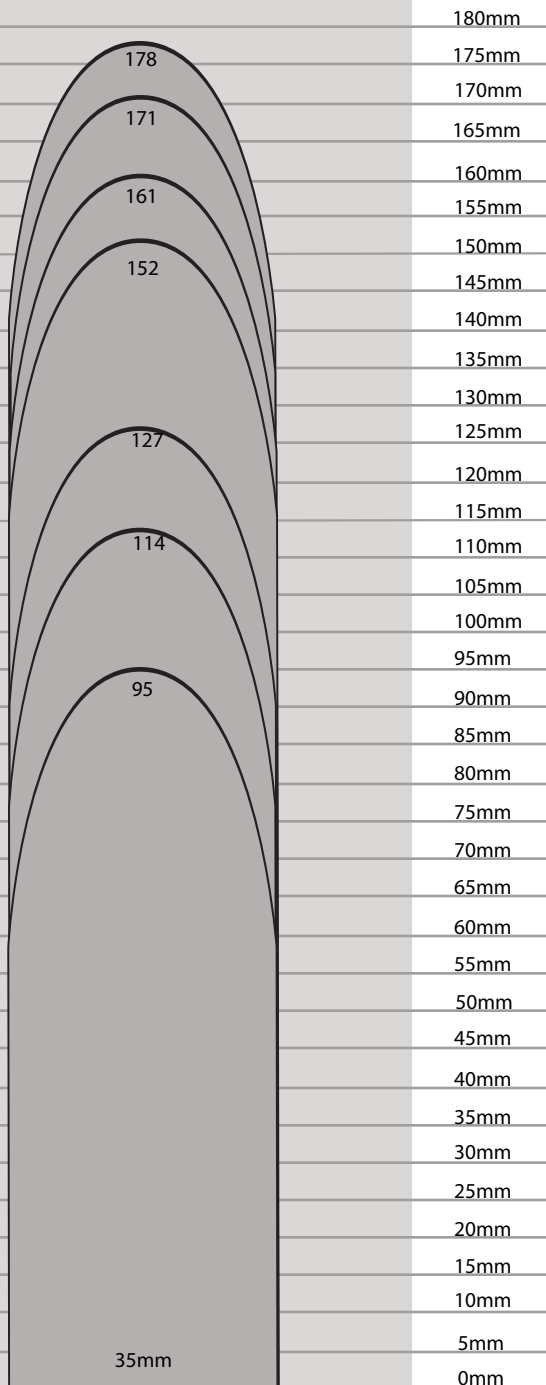

## Graves Vu-More Speculum

Wider blade design with larger view area (4cm vs. standard 3cm) with durable coating.

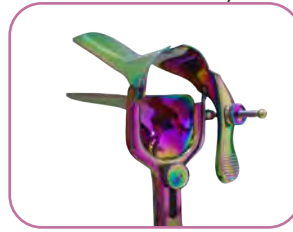

030985 Medium 4½" (114mm)  
030986 Large 5" (127mm)

## Graves Vu-More Speculum

Wider blade design with larger view area (4cm vs. standard 3cm).



030952 Small 3¾" (95mm)  
030953 Medium 4½" (114mm)  
030954 Large 5" (127mm)  
030955 XLong 6" (152mm)  
030956 XLong 6½" (161mm)  
030957 XLong 6¾" (171mm)  
030958 XLong 7" (178mm)

## Graves Vu-Max Speculum

Wider blade design with largest view area (7cm vs. standard 3cm) with durable coating.



030987 Medium 4½" (114mm)  
030988 Large 5" (127mm)

## Graves Vu-Max Speculum

Wider blade design with largest view area (7cm vs. standard 3cm).



030975 Medium 4½" (114mm)  
030976 Large 5" (127mm)  
030977 XLong 6" (152mm)  
030978 XLong 6½" (161mm)  
030979 XLong 6¾" (171mm)  
030980 XLong 7" (178mm)



## Moore Graves Speculum

Short blade design



030920 1 1/4" x 3 1/2"  
(32mm x 89mm)

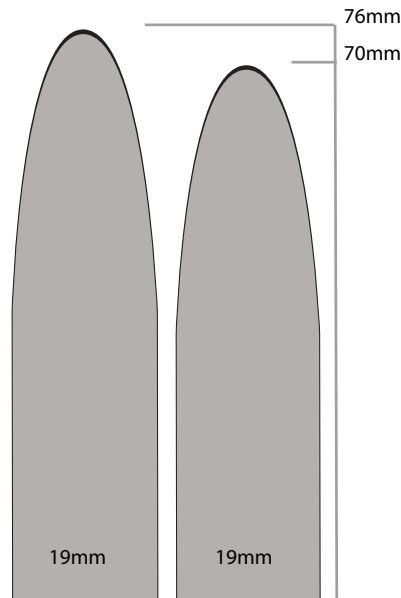

## Graves Speculum

Wider blade design



- 030905 XSmall 3/4" x 2 3/4" (19mm x 70mm)
- 030901 Small 3/4" x 3" (19mm x 76mm)
- 030902 Medium 1 3/8" x 4" (35mm x 102mm)
- 030903 Large 1 3/8" x 4 3/4" (35mm x 121mm)
- 030904 XLarge 1 1/2" x 6 1/2" (38mm x 165mm)
- 030900 Extra Long Snowman Clinton 1 1/2" x 6" (38mm x 152mm)

## Graves Speculum

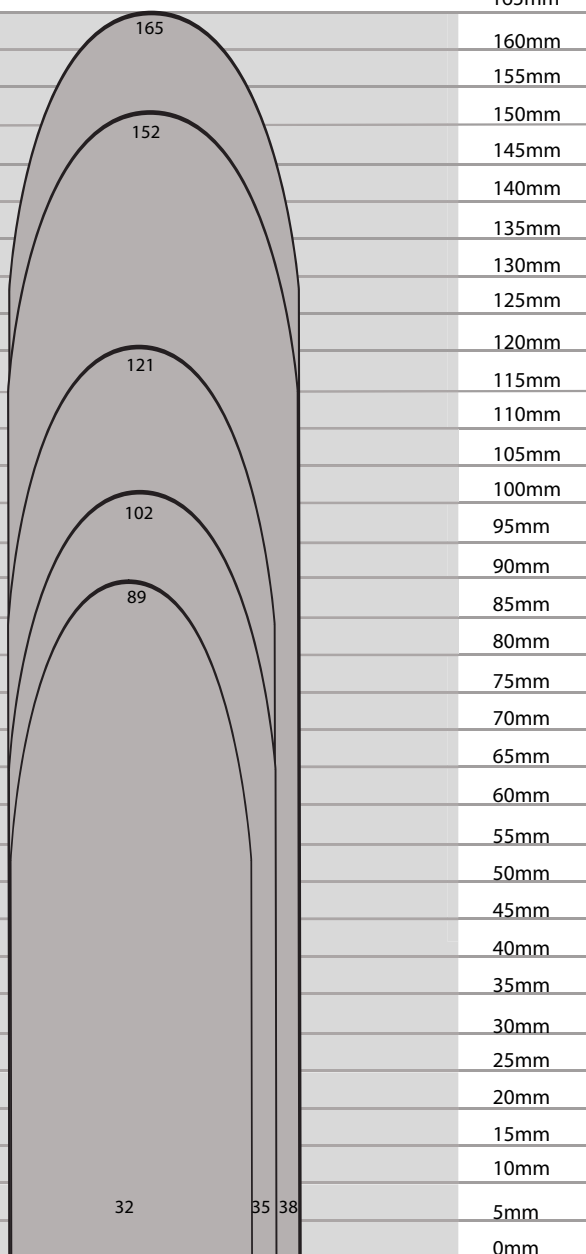

## Graves Wide Angled Speculum

Wider Graves blade design with 45° open angle.



- 030909 Medium 1 3/8" x 4" (35mm x 102mm)
- 030910 Right Side Open Medium 1 3/8" x 4" (35mm x 102mm)
- 030971 Right Side Open Large 1 3/8" x 4 3/4" (35mm x 121mm)

## Weisman Graves Speculum

Open-side speculum



- 030911-SM Small - Right 3/8" x 3" (10mm x 76mm)
- 030911 Medium - Right 1 3/8" x 4" (35mm x 102mm)
- 030911-LG Large - Right 1 3/8" x 4 3/4" (35mm x 121mm)
- 030911-XL XLarge - Right 1 1/2" x 6 1/2" (38mm x 165mm)
- 030912 Medium - Left 1 3/8" x 4" (35mm x 102mm)
- 030912-LG Large - Left 1 3/8" x 4 3/4" (35mm x 121mm)
- 030912-XL XLarge - Left 1 1/2" x 6 1/2" (38mm x 165mm)

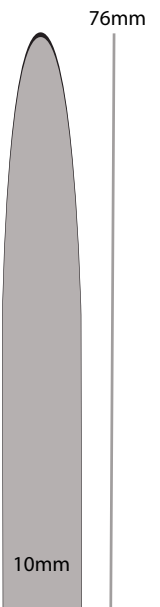

# Speculums

## Pederson Vu-More Speculum

Larger view area (4cm vs. standard 3cm) with durable coating.



030981 Medium 4½" (114mm)  
030982 Large 5" (127mm)

## Pederson Vu-Max Speculum

Largest view area (7cm vs. standard 3cm) with durable coating.



030983 Medium 4½" (114mm)  
030984 Large 5" (127mm)

## Pederson Speculum

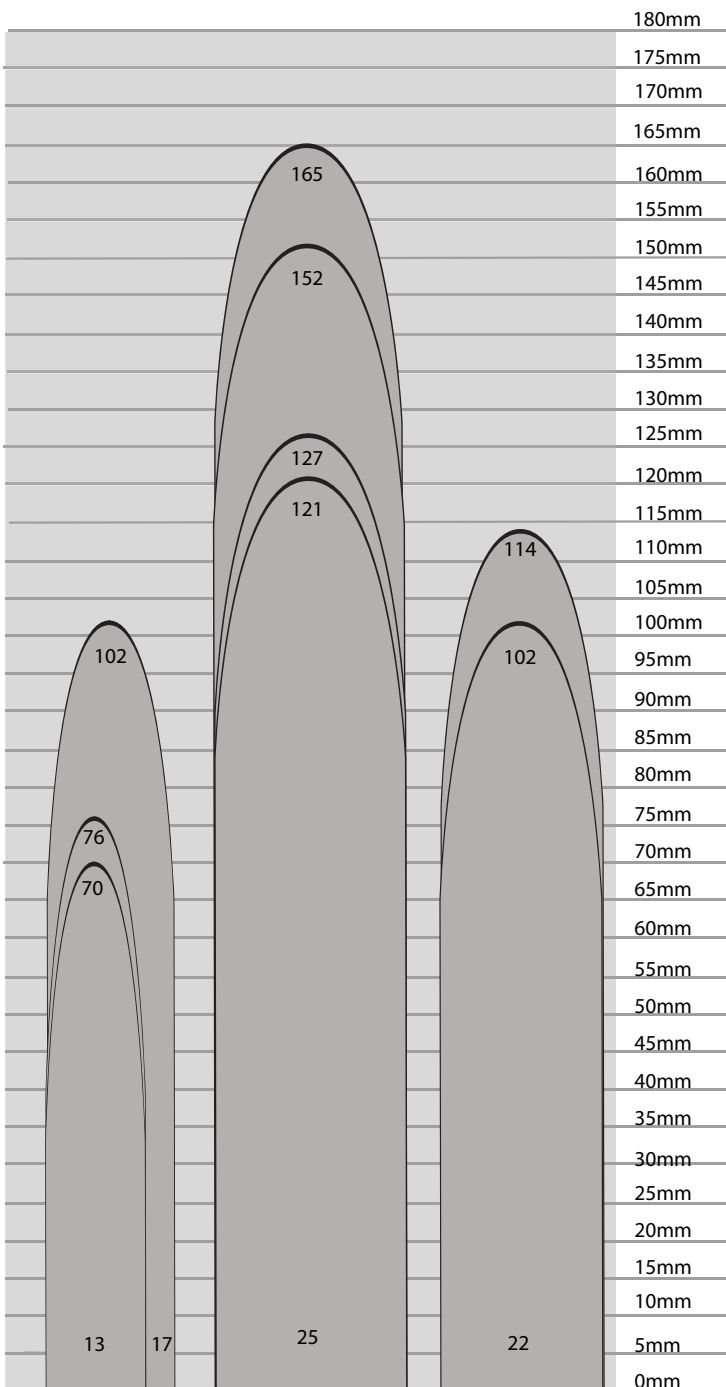

## Pederson Speculum

Narrow blade design



030941 XNarrow ⅝" x 4" (17mm x 102mm)  
030913 XSmall ½" x 2¾" (13mm x 70mm)  
030906 Small ½" x 3" (13mm x 76mm)  
030907 Medium ⅞" x 4" (22mm x 102mm)  
030908 Large 1" x 4¾" (25mm x 121mm)  
030914 XLarge 1" x 6½" (25mm x 165mm)  
030917 Extra Long Snowman Clinton 1" x 6" (25mm x 152mm)

## Pederson - Open Side Speculum

Narrow blade design with open side

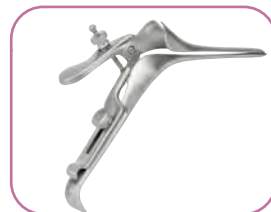

030972 45° Medium - Right ⅞" x 4" (22mm x 102mm)  
030973 45° Large - Right 1" x 4¾" (25mm x 121mm)  
030942 XNarrow - Right ⅝" x 4" (17mm x 102mm)  
030943 XNarrow - Left ⅝" x 4" (17mm x 102mm)  
030939 Medium - Right ⅞" x 4" (22mm x 102mm)  
030939-LT Medium - Left ⅞" x 4" (22mm x 102mm)  
030908R Large - Right 1" x 4¾" (25mm x 121mm)  
030908-LT Large - Left 1" x 4¾" (25mm x 121mm)  
030914-L-XL XLarge - Left 1" x 6½" (25mm x 165mm)  
030914-R-XL XLarge - Right 1" x 6½" (25mm x 165mm)

## Klopper Speculum

Wider opening (4cm) and short blade



030931 1 3/8" x 3 1/2" (35mm x 89mm)

## Grundman Speculum

Wide open design with screw adjustment/lever



030949 Small 1 1/3" x 3 1/3" (34mm x 85mm)

030950 Medium 1 3/8" x 3 3/4" (35mm x 95mm)

030951 Large 1 1/2" x 4 3/4" (38mm x 121mm)

## Cusco Speculum

Unique handle-design speculum with center screw or side screw options.



030960 Small w/Center Screw 1 1/3" x 3 1/2" (34mm x 89mm)

030961 Medium w/Center Screw 1 3/8" x 4" (35mm x 102mm)

030962 Large w/Center Screw 1 3/8" x 4 1/2" (35mm x 114mm)

030963 Small w/Side Screw 1 1/3" x 3 1/2" (34mm x 89mm)

030964 Medium w/Side Screw 1 3/8" x 4" (35mm x 102mm)

030965 Large w/Side Screw 1 3/8" x 4 1/2" (35mm x 114mm)

## Four-Way Speculum

The design of this speculum combines the characteristics of both a standard speculum and a vaginal wall retractor.



038095 4-Way Lateral Expander Speculum - Medium  
7/8" x 4 1/4" (22mm x 108mm)

038096 4-Way Lateral Expander Speculum - Large  
7/8" x 5 1/4" (22mm x 133mm)

## Klopper, Grundman, Cusco, For-Way Speculum

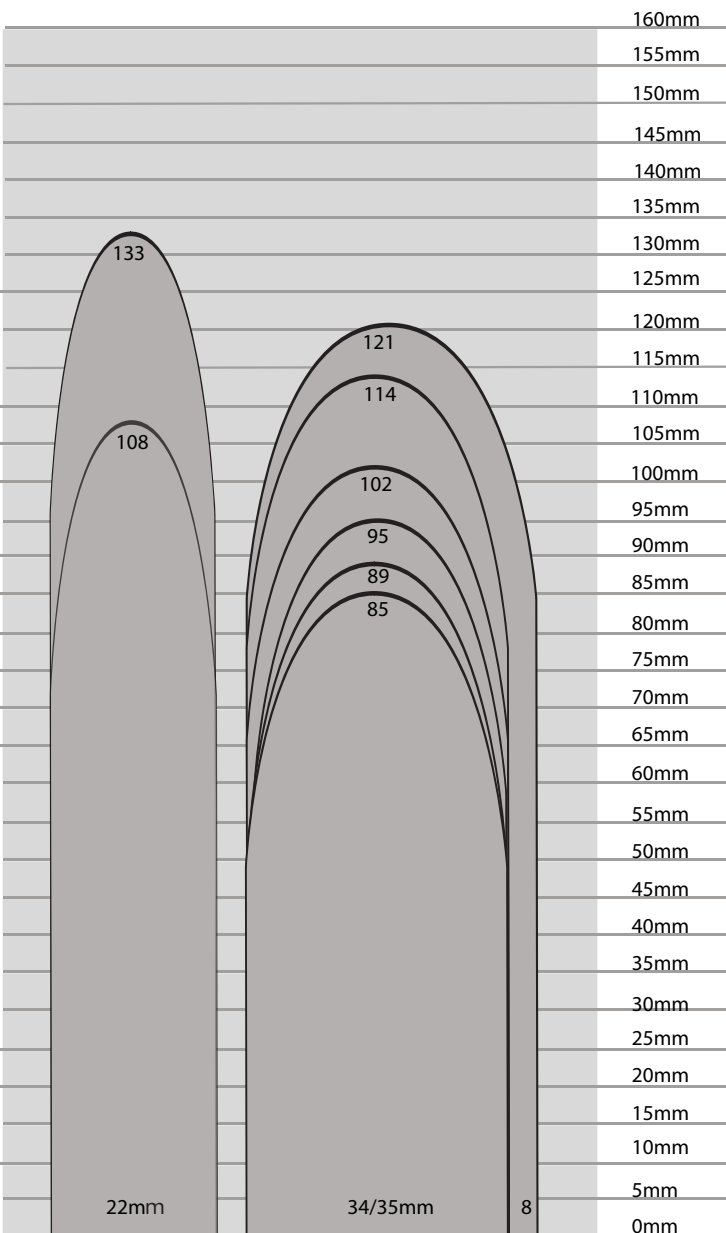

# Speculums

## Weighted Speculum



- 030921 Auvard 2.0lbs, 75° angle,  
Blade 1½" x 3¼" (38mm x 83mm)
- 030922 Auvard 2.5lbs, 75° angle,  
Blade 1½" x 3¼" (38mm x 83mm)
- 030923 Auvard 3.0lbs, 75° angle,  
Blade 1½" x 3¼" (38mm x 83mm)
- 030924 Auvard 2.5lbs, 45° angle,  
Blade 1⅔" x 4" (35mm x 102mm)
- 030926 Auvard 2.5lbs, 90° angle,  
Blade 1" x 5½" (25mm x 140mm)

## Collins Speculum

The unique hands-free design offers the advantages of an open-sided speculum while permitting multiple positioning for optimal exposure with blades that open laterally instead of vertically.



- 030946 1¼" x 3¾" (32mm x 95mm)
- 030947 1⅔" x 4" (35mm x 102mm)
- 030948 1⅝" x 4½" (41mm x 114mm)

## Lateral Vaginal Wall Retractor

Used for the retraction of vaginal wall and made to fit inside any standard speculum to expand past blades of speculum. Allows for greater exposure of cervix for safer, more accurate procedures.



- 030970 Lateral Vaginal Wall Retractor Blue Titanium
- 030966 Open ½" (13mm), 10" (254mm),  
Blade Size 1" x 2½" (25mm x 64mm)
- 030967 Open 1" (25mm), 10" (254mm),  
Blade Size 1" x 2½" (25mm x 64mm)
- 030968 Wide Open, 10" (254mm),  
Blade Size 1" x 2½" (25mm x 64mm)
- 030969 Closed, 10" (254mm),  
Blade Size 1" x 2½" (25mm x 64mm)

## Collins Speculum

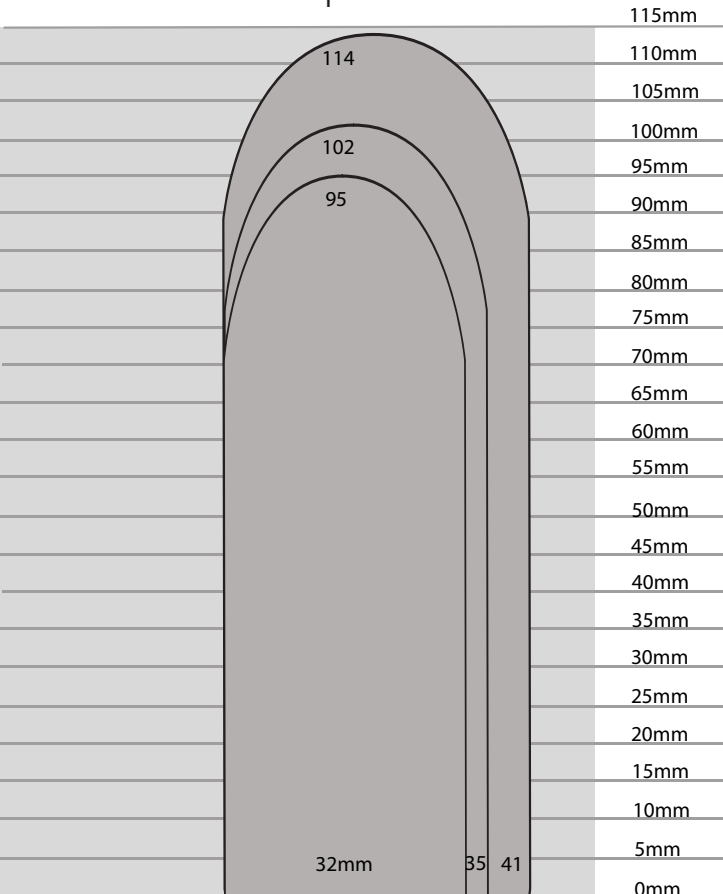

## Endocervical Speculum

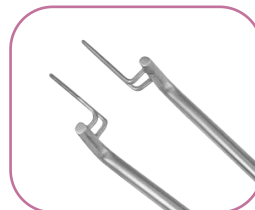

- 030205 Endocervical Speculum Blue Titanium
- 030915 Kogan with Screw 2-4mm
- 030916 Kogan with Screw 4-8mm
- 030201 Kogan with Gauge & Ratchet 2-4mm
- 030202 Kogan with Gauge & Ratchet 4-8mm
- 030203 Kogan with Gauge & Ratchet 8-12mm
- 030204 Townsend Endocervical Speculum 8-12mm

## MedGyn Blue Titanium

### Tischler Biopsy Punch

Classic Tischler bite with durable coating.

Bite Size: 7mm x 3mm



030176 Tischler Biopsy Punch Blue Titanium  
Heavy-Grip Handle 10" (254mm)

030181 Tischler Biopsy Punch Blue Titanium 10"  
(254mm)

### Baby Tischler Biopsy Punch (Forceps Style)

Smaller bite size designed for less trauma with durable coating. Bite Size: 4.2mm x 2.3mm

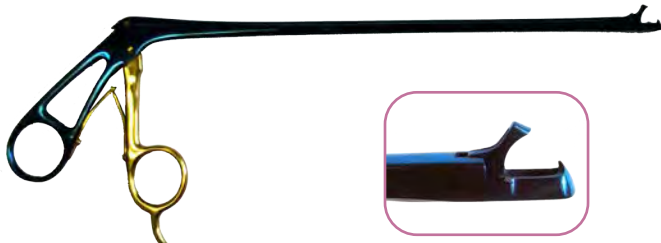

030179 Baby Tischler Biopsy Punch Blue Titanium  
Gold Handle (Forceps Style) 10" (254mm)

### Oval Tischler Biopsy Punch

Oval Tischler bite with durable coating and a heavy-grip handle.



030175 Oval Tischler Biopsy Punch Blue Titanium  
Heavy-Grip Handle 10" (254mm)

### Baby Tischler Biopsy Punch

Smaller bite size designed for less trauma with durable coating. Bite Size: 4.2mm x 2.3mm



030177 Baby Tischler Biopsy Punch Blue Titanium  
Heavy-Grip Handle 10" (254mm)

030129 Baby Tischler Biopsy Punch Blue Titanium  
8½" (216mm)

030180 Baby Tischler Biopsy Punch Blue Titanium  
10" (254mm)

### Kevorkian Biopsy Punch

Popular design with strong, narrow jaw with durable coating and a heavy-grip handle. Bite Size: 8mm x 3mm



030178 Kevorkian Biopsy Punch Blue Titanium  
Heavy-Grip Handle 10" (254mm)

## MedGyn Titanium

### Tischler Biopsy Punch

Classic Tischler bite, with durable coating.

Bite Size: 7mm x 3mm



030172 Tischler Biopsy Punch Titanium 10" (254mm)  
Heavy-Grip Handle

030120 Tischler Biopsy Punch Titanium 10" (254mm)

030124 Tischler Biopsy Punch Titanium 10" (254mm) - Angled Up

030125 Tischler Biopsy Punch Titanium 10" (254mm) - Angled Down

030162 Tischler Biopsy Punch Titanium 10" (254mm) - Angled Left

030163 Tischler Biopsy Punch Titanium 10" (254mm) - Angled Right

030118 Tischler Biopsy Punch Titanium 8½" (216mm)

030122 Tischler Biopsy Punch Titanium 8½" (216mm) - Angled Up

030123 Tischler Biopsy Punch Titanium 8½" (216mm) - Angled Down

030138 Tischler Biopsy Punch Titanium 8½" (216mm) - Angled Right

030139 Tischler Biopsy Punch Titanium 8½" (216mm) - Angled Left

030173 Baby Tischler Biopsy Punch Titanium 10" (254mm)  
Heavy-Grip Handle

030121 Baby Tischler Biopsy Punch Titanium 10" (254mm)

030134 Baby Tischler Biopsy Punch Titanium 10" (254mm) - Angled Up

030135 Baby Tischler Biopsy Punch Titanium 10" (254mm) - Angled Down

030161 Baby Tischler Biopsy Punch Titanium 10" (254mm) - Angled Left

030160 Baby Tischler Biopsy Punch Titanium 10" (254mm) - Angled Right

030119 Baby Tischler Biopsy Punch Titanium 8½" (216mm)

030132 Baby Tischler Biopsy Punch Titanium 8½" (216mm) - Angled Up

030133 Baby Tischler Biopsy Punch Titanium 8½" (216mm) Angled Down

030159 Baby Tischler Biopsy Punch Titanium 8½" (216mm) - Left

030158 Baby Tischler Biopsy Punch Titanium 8½" (216mm) - Right

### Baby Tischler Biopsy Punch

Smaller bite size designed for less trauma with durable coating. Bite Size: 4.2mm x 2.3mm



### Baby Tischler Biopsy Punch (Forceps Style)

Classic Baby Tischler bite with durable coating.

Bite Size: 4.2mm x 2.3mm



030170 Baby Tischler Biopsy Punch Titanium  
Gold Handle (Forceps Style) 10" (254mm)

### Kevorkian Biopsy Punch

Popular design with strong, narrow jaw with durable coating. Bite Size: 8mm x 3mm.

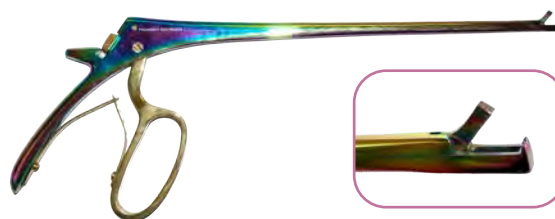

030174 Kevorkian Biopsy Punch Titanium Heavy-Grip  
Handle 10" (254mm)

030127 Kevorkian Biopsy Punch Titanium 10" (254mm)

030126 Kevorkian Biopsy Punch Titanium 8½" (216mm)

### Oval Tischler Biopsy Punch



030171 Oval Tischler Biopsy Punch Titanium Heavy-Grip Handle  
10" (254mm)

## MedGyn Stainless Steel

### Tischler Biopsy Punch

Classic Tischler bite designed for drawing in maximum tissue near Os with minimal trauma.

Bite Size 7mm x 3mm



- 030101-10 Tischler Biopsy Punch 10" (254mm)
- 029801 Tischler Biopsy Punch 10" (254mm) Angled Up
- 029802 Tischler Biopsy Punch 10" (254mm) Angled Down
- 029803 Tischler Biopsy Punch 10" (254mm) Angled Left
- 029804 Tischler Biopsy Punch 10" (254mm) Angled Right
- 030101 Tischler Biopsy Punch 8½" (216mm)
- 030113 Tischler Biopsy Punch 8½" (216mm) Angled Up
- 030114 Tischler Biopsy Punch 8½" (216mm) Angled Down
- 030136 Tischler Biopsy Punch 8½" (216mm) Angled Left
- 030137 Tischler Biopsy Punch 8½" (216mm) Angled Right

- 030102-10 Baby Tischler Biopsy Punch 10" (254mm)
- 029811 Baby Tischler Biopsy Punch 10" (254mm) Angled Up
- 029812 Baby Tischler Biopsy Punch 10" (254mm) Angled Down
- 029813 Baby Tischler Biopsy Punch 10" (254mm) Angled Left
- 029814 Baby Tischler Biopsy Punch 10" (254mm) Angled Right
- 030102 Baby Tischler Biopsy Punch 8½" (216mm)
- 030140 Baby Tischler Biopsy Punch 8½" (216mm) Angled Up
- 030141 Baby Tischler Biopsy Punch 8½" (216mm) Angled Down
- 030142 Baby Tischler Biopsy Punch 8½" (216mm) Angled Left
- 030143 Baby Tischler Biopsy Punch 8½" (216mm) Angled Right

### Baby Tischler Biopsy Punch

Smaller bite size designed for less trauma.

Bite Size: 4.2mm x 2.3mm



### Kevorkian Biopsy Punch

(Kevorkian-Younger Biopsy Forceps displayed)



- 030103-10 Kevorkian Biopsy Punch 10" (254mm)
- 030103 Kevorkian Biopsy Punch 8½" (216mm)
- 030169 Kevorkian-Younger Biopsy Forceps without Spring 8" (203mm)

### Tischler-Kevorkian Cervical Biopsy Punch

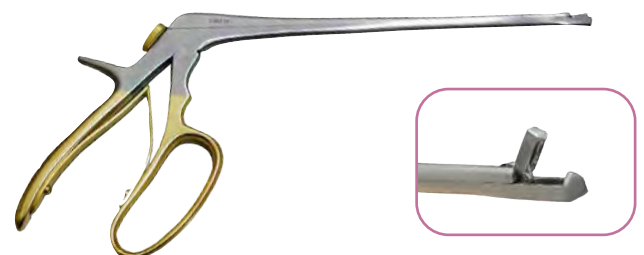

- 030116 Tischler-Kevorkian Biopsy Punch 10" (254mm)
- 030115 Tischler-Kevorkian Biopsy Punch 8½" (216mm)

### Burke Biopsy Punch

Open-handle design for optimal control with small cutting jaws and sharp teeth.

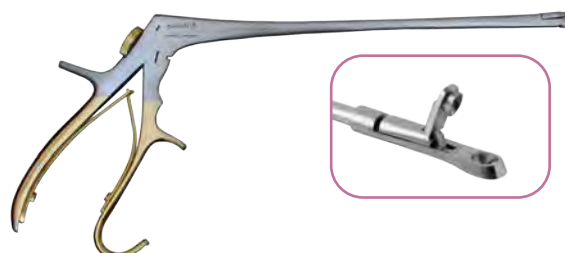

- 030109 Burke Biopsy Punch 8½"

# Biopsy Punches

## MedGyn Stainless Steel

### Eppendorfer Biopsy Forceps

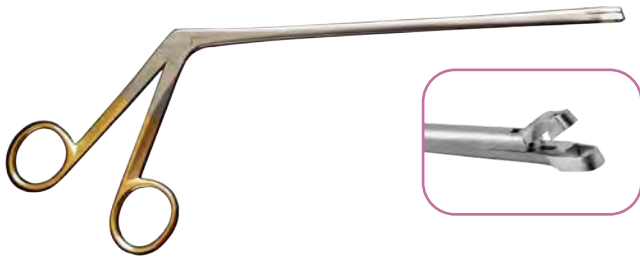

030110 Eppendorfer Biopsy Forceps 8" (203mm)

### Van Doren Biopsy Forceps

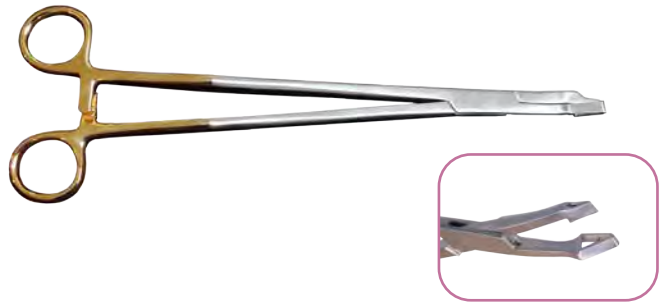

030155 Van Doren Biopsy Forceps with Ratchet 10" (254mm)  
030166 Van Doren Biopsy Forceps without Ratchet 10" (254mm)

### Schubert Biopsy Forceps

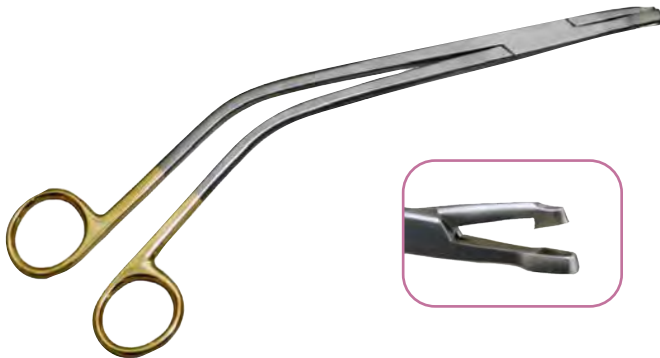

030157 Schubert Biopsy Forceps 10" (254mm) Curved  
Rotating Biopsy Punch Options

### Wittner Biopsy Punch



030117 Wittner Biopsy Punch 8 1/2" (216mm)



- 030778 Vulvar Keyes Biopsy Punch Set (Handle + 6 Tips)
- 030104 Rotating Tischler Biopsy Punch
- 030145 Rotating Tischler Biopsy Punch - Angled Down
- 030146 Rotating Tischler Biopsy Punch - Angled Up
- 030105 Rotating Baby Tischler Biopsy Punch
- 030105-DOWN Rotating Baby Tischler Biopsy Punch - Angled Down
- 030105-UP Rotating Baby Tischler Biopsy Punch - Angled Up
- 030106 Rotating Kevorkian Biopsy Punch



- 030107 Rotating Burke Biopsy Punch
- 030111-BB Rotating Shaft - Baby Tischler Tip Only
- 030111-BRK Rotating Shaft - Burke Tip Only
- 030111-KEV Rotating Shaft - Kevorkian Tip Only
- 030111-TIS Rotating Shaft - Tischler Tip Only
- 030147 Rotating Shaft- Tischler Tip - Up
- 030148 Rotating Shaft - Tischler Tip - Down
- 030108 Rotating Biopsy Punch Handle Only
- 030100 Rotating Shaft (with any tip)



## MedGyn Tenaculums

### Schroeder Braun Single-Tooth Tenaculum



- 031004 Schroeder Braun Single-Tooth - 9¾" (248mm)
- 031019 Schroeder Braun Tenaculum Light-Touch Straight - 9¾" (248mm)
- 031034 Schroeder Braun Tenaculum Economy - 9¾" (248 mm)
- 031018 Braun Tenaculum Light-Touch Round - 7¼" (184mm)

### Skene Single-Tooth Tenaculum



- 031006 Skene Single-Tooth-Side-Curve - 10" (254mm)

### Duplay Single-Tooth Tenaculum



- 031008 Duplay Single-Tooth Double-Curve - 11" (279mm)

### Jacobson Double-Tooth Tenaculum



- 031199 Jacobson Double-Tooth 10" Straight - 2x2 Teeth with Larger Rings (254mm)
- 031200 Jacobson Double-Tooth 10" Side Curve - 2x2 Teeth with Larger Rings (254mm)

### Barrett Tenaculum



- 031009 Barrett Straight - 7¼" (184mm)

### Jacobs Double-Tooth Tenaculum



- 031197 Jacobs Double-Tooth 8½" Straight - 2x2 Teeth (215mm)
- 031198 Jacobs Double-Tooth 8½" Side Curve - 2x2 Teeth (215mm)

### Schroeder Double-Tooth Tenaculum

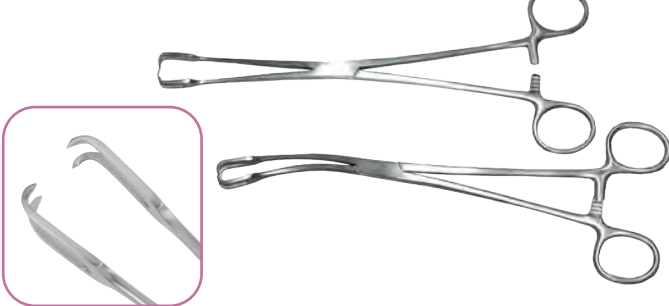

- 031011 Schroeder Double-Tooth - 10" Straight (254mm)
- 031012 Schroeder Double-Tooth - 10" Curved (254mm)
- 031013 Schroeder Double-Tooth - 10" Side Curve (254mm)

## MedGyn Tenaculums

### Bierer Tenaculum

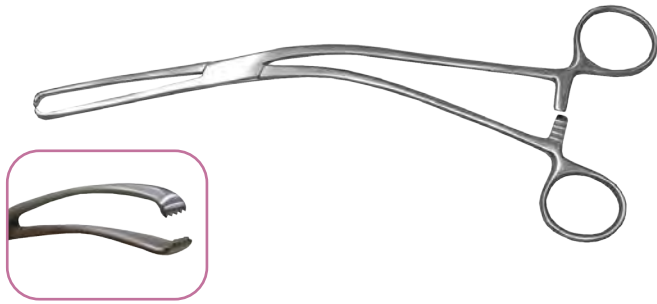

- 031010 Bierer Angled 5x6 Teeth, 9" (229mm)
- 031033 Bierer Angled 5x6 Teeth, Economy 9" (229mm)

### Kelly Tenaculum

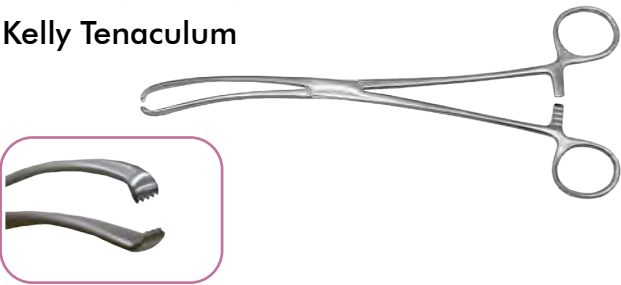

- 031017 Kelly Tenaculum 4X5 Teeth, 9" (229mm)



- 031016 Shah Tenaculum 9½" (241mm)

### Emmett Tenaculum Hooks



- 031401 Emmett Curved Hook 9½" (241mm)
- 031402 Emmett Half-Curved Hook 9¾" (248mm)
- 031403 Emmett Hook L-Shaped 9" (229mm)

### Teale Tenaculum

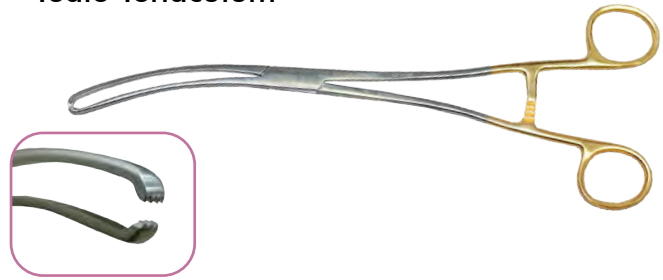

- 031005 Teale Curved, 3x4 Teeth, 5mm Wide, 10" (254mm)

### Atraumatic Tenaculum

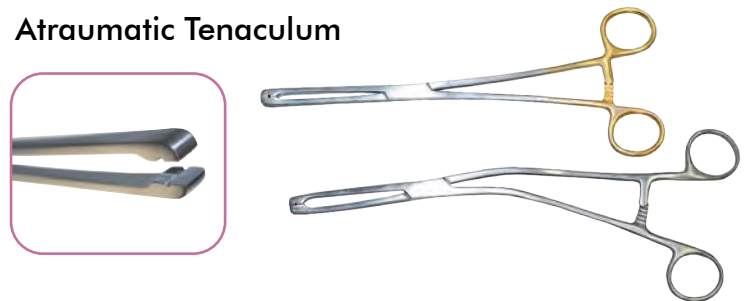

- 031001 Atraumatic Straight ¼" (6mm) Jaws, 9" (229mm)
- 031002 Atraumatic Straight ⅜" (3mm) Jaws, 9" (229mm)
- 031003 Atraumatic Angled ¼" (6mm) Jaws, 9½" (241mm)

### Iris Hook



- 030406 Iris Hook 10" (254mm)

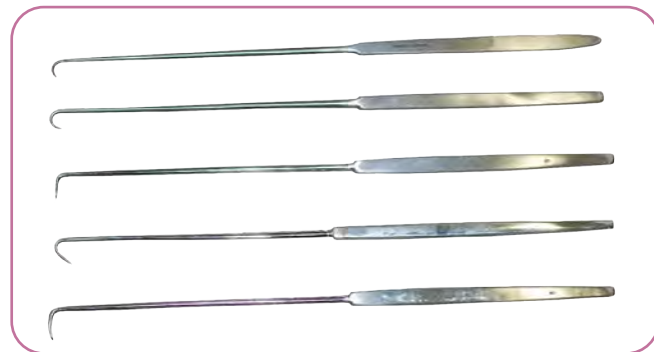

- 031404 Emmett Hook Acute Angle 9" (229mm)
- 031405 Emmett Hook Double Angled 9" (229mm)

## MedGyn Double-End Dilators



### Pratt Dilator

Stainless steel double-end dilator 11½" (292mm).

- 030850 Pratt 8 Piece Dilator Set 13-15 Fr - 41-43 Fr
- 030850-ECO Pratt 8 Piece Dilator Set 13-15 Fr -41-43 Fr
- 030859 Pratt Dilator 9-11Fr
- 030851 Pratt Dilator 13-15 Fr
- 030852 Pratt Dilator 17-19 Fr
- 030853 Pratt Dilator 21-23 Fr
- 030854 Pratt Dilator 25-27 Fr
- 030855 Pratt Dilator 29-31 Fr
- 030856 Pratt Dilator 33-35 Fr
- 030857 Pratt Dilator 37-39 Fr
- 030858 Pratt Dilator 41-43 Fr



### Hank Dilator

Designed with guide rings for ease-of-use 11" (279mm)

- 030801 Hank 6 Piece Dilator Set 11-12 Fr - 21-22 Fr
- 030801-7 Hank 7 Piece Dilator Set 9-10 Fr - 21-22 Fr
- 030801-7/8 Hank Dilator 7-8 Fr
- 030801-9/10 Hank Dilator 9-10 Fr
- 030801-11/12 Hank Dilator 11-12 Fr
- 030801-13/14 Hank Dilator 13-14 Fr
- 030801-15/16 Hank Dilator 15-16 Fr
- 030801-17/18 Hank Dilator 17-18 Fr
- 030801-19/20 Hank Dilator 19-20 Fr
- 030801-21/22 Hank Dilator 21-22 Fr



### Pratt Extra Large Dilator

Pratt style in larger sizes 11½" (292mm).

- 030870 Pratt Extra Large 9 Piece Dilator Set 45-47 Fr - 77-79 Fr
- 030870-ECO Pratt Extra Large 9 Piece Dilator Set 45-47 Fr - 77-79 Fr
- 030871 Pratt Dilator Extra Large 45-47 Fr
- 030872 Pratt Dilator Extra Large 49-51 Fr
- 030873 Pratt Dilator Extra Large 53-55 Fr
- 030874 Pratt Dilator Extra Large 57-59 Fr
- 030875 Pratt Dilator Extra Large 61-63 Fr
- 030876 Pratt Dilator Extra Large 65-67 Fr
- 030877 Pratt Dilator Extra Large 69-71 Fr
- 030878 Pratt Dilator Extra Large 73-75 Fr
- 030879 Pratt Dilator Extra Large 77-79 Fr
- 030880 Pratt Extra Large, Light Weight 9 Piece Dilator Set 45-47 Fr - 77-79 Fr
- 030881 Pratt Extra Large, Light Weight 45-47 Fr
- 030882 Pratt Extra Large, Light Weight 49-51 Fr
- 030883 Pratt Extra Large, Light Weight 53-55 Fr
- 030884 Pratt Extra Large, Light Weight 57-59 Fr
- 030885 Pratt Extra Large, Light Weight 61-63 Fr
- 030886 Pratt Extra Large, Light Weight 65-67 Fr
- 030887 Pratt Extra Large, Light Weight 69-71 Fr
- 030888 Pratt Extra Large, Light Weight 73-75 Fr
- 030889 Pratt Extra Large, Light Weight 77-79 Fr



### Hegar Dilator

Stainless steel double-end dilator 7½" (191mm).

- 030830 Hegar 8 Piece Dilator Set 3-4mm - 17-18mm
- 030831 Hegar Dilator 1-2mm
- 030832 Hegar Dilator 3-4mm
- 030833 Hegar Dilator 5-6mm
- 030834 Hegar Dilator 7-8mm
- 030835 Hegar Dilator 9-10mm
- 030836 Hegar Dilator 11-12mm
- 030837 Hegar Dilator 13-14mm
- 030838 Hegar Dilator 15-16mm
- 030839 Hegar Dilator 17-18mm



### Kleegman Dilator

Double-end dilator available in stainless steel and Teflon™. (Stainless steel pictured) (1.0mm/2.0mm)

- 030804 Kleegman Stainless Steel Dilator 11" (279mm)
- 030805 Kleegman Teflon™ Dilator 12" (305mm)

## MedGyn Single-End Dilators

### Hegar Dilator

Stainless steel single-end dilator 7 1/2" (191mm).



- 030841-1 Hegar Dilator 1mm
- 030841-1.5 Hegar Dilator 1.5mm
- 030841-2 Hegar Dilator 2mm
- 030841-2.5 Hegar Dilator 2.5mm
- 030841-3 Hegar Dilator 3mm
- 030841-3.5 Hegar Dilator 3.5mm
- 030841-4 Hegar Dilator 4mm
- 030841-4.5 Hegar Dilator 4.5mm
- 030841-5 Hegar Dilator 5mm
- 030841-5.5 Hegar Dilator 5.5mm
- 030842-6 Hegar Dilator 6mm
- 030842-6.5 Hegar Dilator 6.5mm
- 030842-7 Hegar Dilator 7mm
- 030842-7.5 Hegar Dilator 7.5mm
- 030842-8 Hegar Dilator 8mm
- 030842-8.5 Hegar Dilator 8.5mm
- 030842-9 Hegar Dilator 9mm
- 030842-9.5 Hegar Dilator 9.5mm
- 030842-10 Hegar Dilator 10mm
- 030842-10.5 Hegar Dilator 10.5mm
- 030843-11 Hegar Dilator 11mm

- 030843-11.5 Hegar Dilator 11.5mm
- 030843-12 Hegar Dilator 12mm
- 030843-12.5 Hegar Dilator 12.5mm
- 030843-13 Hegar Dilator 13mm
- 030843-13.5 Hegar Dilator 13.5mm
- 030843-14 Hegar Dilator 14mm
- 030843-14.5 Hegar Dilator 14.5mm
- 030843-15 Hegar Dilator 15mm
- 030843-15.5 Hegar Dilator 15.5mm
- 030844-16 Hegar Dilator 16mm
- 030844-16.5 Hegar Dilator 16.5mm
- 030844-17 Hegar Dilator 17mm
- 030844-17.5 Hegar Dilator 17.5mm
- 030844-18 Hegar Dilator 18mm
- 030844-18.5 Hegar Dilator 18.5mm

### Hern Dilator

Teflon single-end dilator with handle 14 3/4" (375mm).



030807 Hern 21 Piece Dilator Set Sizes 44 Fr - 104

- |                           |                           |                           |                                |
|---------------------------|---------------------------|---------------------------|--------------------------------|
| 030808 Hern Dilator 44 Fr | 030814 Hern Dilator 62 Fr | 030820 Hern Dilator 80 Fr | 030826 Hern Dilator 98 Fr      |
| 030809 Hern Dilator 47 Fr | 030815 Hern Dilator 65 Fr | 030821 Hern Dilator 83 Fr | 030827 Hern Dilator 101 Fr     |
| 030810 Hern Dilator 50 Fr | 030816 Hern Dilator 68 Fr | 030822 Hern Dilator 86 Fr | 030828 Hern Dilator 104 Fr     |
| 030811 Hern Dilator 53 Fr | 030817 Hern Dilator 71 Fr | 030823 Hern Dilator 89 Fr | 030829-107 Hern Dilator 107 Fr |
| 030812 Hern Dilator 56 Fr | 030818 Hern Dilator 74 Fr | 030824 Hern Dilator 92 Fr | 030829-110 Hern Dilator 110 Fr |
| 030813 Hern Dilator 59 Fr | 030819 Hern Dilator 77 Fr | 030825 Hern Dilator 95 Fr | 030829-113 Hern Dilator 113 Fr |

### Hawkin Ambler

Stainless steel single-end, dilator 7 1/4" (184mm).



030780 16 Piece Dilator Set Sizes 3-6mm - 18-21mm

- |                                     |                                      |                                      |
|-------------------------------------|--------------------------------------|--------------------------------------|
| 030781 Hawkin Ambler Dilator 3-6mm  | 030786 Hawkin Ambler Dilator 8-11mm  | 030791 Hawkin Ambler Dilator 13-16mm |
| 030782 Hawkin Ambler Dilator 4-7mm  | 030787 Hawkin Ambler Dilator 9-12mm  | 030792 Hawkin Ambler Dilator 14-17mm |
| 030783 Hawkin Ambler Dilator 5-8mm  | 030788 Hawkin Ambler Dilator 10-13mm | 030793 Hawkin Ambler Dilator 15-18mm |
| 030784 Hawkin Ambler Dilator 6-9mm  | 030789 Hawkin Ambler Dilator 11-14mm | 030794 Hawkin Ambler Dilator 16-19mm |
| 030785 Hawkin Ambler Dilator 7-10mm | 030790 Hawkin Ambler Dilator 12-15mm | 030795 Hawkin Ambler Dilator 17-20mm |
|                                     |                                      | 030796 Hawkin Ambler Dilator 18-21mm |

### Pratt Dilator Plastic

Light-weight, reusable 5 piece plastic dilator set.



030890 Pratt Dilator Plastic 5 Piece Set 5-6mm-13-14mm

### McMahan Cervico Meter

Angled, used for measuring dilation of cervix.



031300 McMahan Cervico Meter

### Bartholyn Lacrymal Probe

022718 Bartholyn Lacrymal Probe

### Os Cervical Finder Set

Made of soft, malleable Teflon™. 3 piece set (Os Finder, Canal Finder & Fundus Finder)



030803 Os Cervical Finder 3 Piece Set

### Mini Dilator Set

6 piece set (5 dilators & handle).



030779BT Mini Dilator Set Blue Titanium

030779 6 Piece Mini Dilator Set:

1mm, 1.5mm, 2mm, 2.5mm, 3mm



## MedGyn Endometrial Curettes

### Sims Curette

Metal curette with sharp blade on malleable or rigid shanks 11" (279mm).

030640 Sims Malleable Curette 8 Piece Set Sizes

#00 - #6

030640 12 Sims Malleable Curette 12 Piece Set Sizes #00-10

030641 Sims Malleable Curette #00

030642 Sims Malleable Curette #0

030643 Sims Malleable Curette #1

030644 Sims Malleable Curette #2

030645 Sims Malleable Curette #3

030646 Sims Malleable Curette #4

030647 Sims Malleable Curette #5

030648 Sims Malleable Curette #6

030649 Sims Malleable Curette #7

030637 Sims Malleable Curette #8

030638 Sims Malleable Curette #9

030639 Sims Malleable Curette #10

030650 Sims Rigid Curette 8 Piece Set Sizes #00 - #6

030651 Sims Rigid Curette #00

030652 Sims Rigid Curette #0

030653 Sims Rigid Curette #1

030654 Sims Rigid Curette #2

030655 Sims Rigid Curette #3

030656 Sims Rigid Curette #4

030657 Sims Rigid Curette #5

030658 Sims Rigid Curette #6

030659 Sims Rigid Curette #7

030660 Sims Rigid Curette #8

030661 Sims Rigid Curette #9



### Novak Curette

Popular metal curette available in a 3 piece set or in individual sizes.

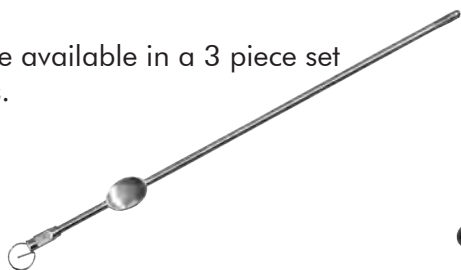

### Banjo/Hunter Curette

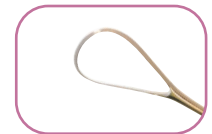

030600 Novak Curette 3 Piece Set 2mm - 4mm 9<sup>3</sup>/<sub>4</sub>" (248mm)

030602 Novak Curette 2mm 9<sup>3</sup>/<sub>4</sub>" (248mm)

030603 Novak Curette 3mm 9<sup>3</sup>/<sub>4</sub>" (248mm)

030604 Novak Curette 4mm 9<sup>3</sup>/<sub>4</sub>" (248mm)

030619 Banjo/Hunter Curette Size 14 - 30mm

### Randall Curette

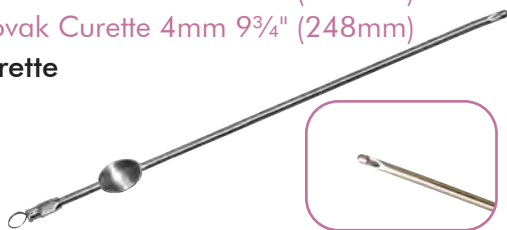

030610 Randall Curette 3 Piece Set #2 - #4 9<sup>3</sup>/<sub>4</sub>" (248mm)

030612 Randall Curette #1 9<sup>3</sup>/<sub>4</sub>" (248mm)

030613 Randall Curette #2 9<sup>3</sup>/<sub>4</sub>" (248mm)

030614 Randall Curette #3 9<sup>3</sup>/<sub>4</sub>" (248mm)

### Evans Curette

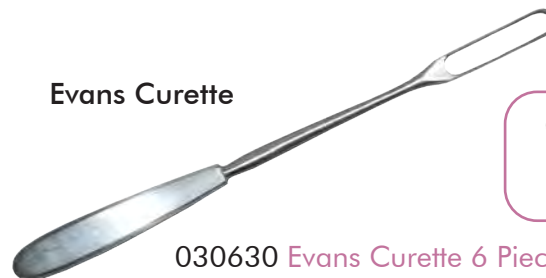

030630 Evans Curette 6 Piece Set Sizes #0 - #5 11" (279mm)

030631 Evans Curette #0-4mm 11" (279mm)

030632 Evans Curette #1-6mm 11" (279mm)

030633 Evans Curette #2-8mm 11" (279mm)

030634 Evans Curette #3-10mm 11" (279mm)

030635 Evans Curette #4-12mm 11" (279mm)

030636 Evans Curette #5-14mm 11" (279mm)

### Bumm Curette

Extra-large metal curettes on malleable shanks

030620 4 Piece Set - Sizes #1 - #4 12" (305mm)

030621 Bumm - Size #1 12" (305mm)

030622 Bumm - Size #2 12" (305mm)

030623 Bumm - Size #3 12" (305mm)

030624 Bumm - Size #4 12" (305mm)

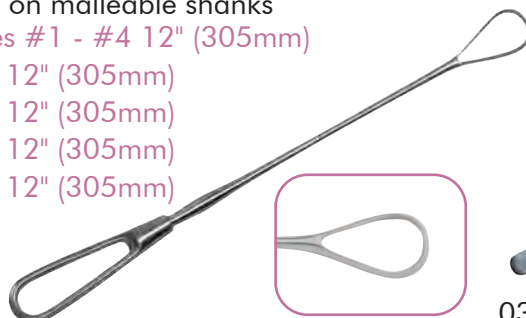

### Heaney Curette



030680 Heaney Curette Small 9<sup>1</sup>/<sub>2</sub>" (241mm)

## MedGyn Endocervical Curettes

### Kevorkian-Youngue Curette

Metal curette available with or without basket.



030316 Spiral Endocervical Curette Blue Titanium

030301 Kevorkian-Youngue Malleable Curette w/o Basket 12" (305mm)

030302 Kevorkian-Youngue Malleable Curette with Basket 12" (305mm)

030303 Kevorkian-Youngue Rigid Curette w/o Basket 12" (305mm)

030304 Kevorkian-Youngue Rigid Curette with Basket 12" (305mm)

030303-H Kevorkian-Youngue Rigid Curette w/o Basket (Square Tip, Gold Handle, Heavy) 12" (305mm)

030304-H Kevorkian-Youngue Rigid Curette with Basket (Square Tip, Gold Handle, Heavy) 12" (305mm)

030315 Kevorkian-Youngue Rigid Curette w/o Basket (Square Tip, Titanium) 12" (305mm)

030311 Kevorkian-Youngue Rigid Curette with Basket (Square Tip, Titanium) 12" (305mm)

030306 Kevorkian-Youngue Rigid Curette with Basket (Round Tip, Gold Handle, Heavy) 12" (305mm)

030310 Kevorkian-Youngue Rigid Curette with Basket (Round Tip, Titanium) 12" (305mm)

Kevorkian-Youngue  
w/o Basket

Kevorkian-Youngue  
with Basket

### Townsend Curette

Round, tapered tip allows for entry through stenotic os.

030305 Townsend Curette 12" (305mm)



## Metal Uterine Sounds

MedGyn reusable, graduated metal sounds made of highly malleable metal.

### Sims Uterine Sound



030700 Sims Uterine Sound 3mm Diameter, Graduated in inches, 13" (330mm)

030701 Sims Uterine Sound 3mm Diameter, Graduated in cm, 13" (330mm)

030702 Sims Uterine Sound 2mm Diameter, Graduated in cm, 13" (330mm)

030703 Sims Uterine Sound 3mm Plain Probe, Malleable, 13" (330mm)

### Simpson Uterine Sound



030704 Simpson Uterine Sound 3mm Diameter, Graduated in inches, 13" (330mm)

030705 Simpson Uterine Sound 3mm Diameter, Graduated in cm, 13" (330mm)

## MedGyn Ovum Forceps

### Sopher Ovum Forceps

Slightly curved forceps with oval, serrated jaws.

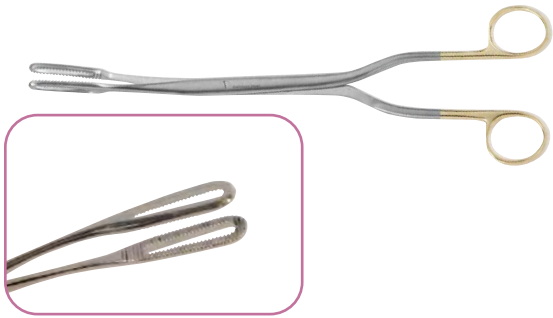

- 031123 Sopher Ovum Forceps 11" (279mm) 12mm Jaws
- 031123R Sopher Ovum Forceps 11" (279mm) 12mm Jaws with Ratchet
- 031126 Sopher Ovum Forceps 11" (279mm) 14mm Jaws
- 031149 Sopher Ovum Forceps 11" (279mm) 14mm Jaws with Ratchet
- 031124 Sopher Ovum Forceps 13" (330mm) 12mm Jaws
- 031125 Sopher Ovum Forceps 13" (330mm) 12mm Jaws with Ratchet
- 031127 Sopher Ovum Forceps 13" (330mm) 14mm Jaws
- 031128 Sopher Ovum Forceps 13" (330mm) 14mm Jaws w. Ratchet

### Bierer Ovum Forceps

Slightly curved forceps with oval, coarse, serrated jaws.

- 031131 Bierer Ovum Forceps 11"(279mm) 16mm Jaws
- 031132 Bierer Ovum Forceps 11"(279mm) 16mm Jaws with Ratchet
- 031135 Bierer Ovum Forceps 11" (279mm) 19mm Jaws
- 031136 Bierer Ovum Forceps 11" (279mm) 19mm Jaws with Ratchet
- 031133 Bierer Ovum Forceps 13" (330mm) 16mm Jaws
- 031134 Bierer Ovum Forceps 13" (330mm) 16mm Jaws with Ratchet
- 031137 Bierer Ovum Forceps 13" (330mm) 19mm Jaws
- 031138 Bierer Ovum Forceps 13" (330mm) 19mm Jaws with Ratchet

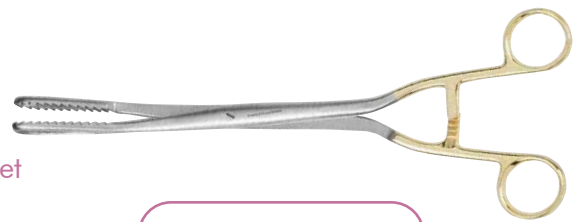

### Sopher Original Forceps

Slightly curved forceps with oval jaw. Concave tip design to prevent grasping of fundus.



- 031129 Sopher Original Forceps 10½" (267mm) Small Jaws
- 031130 Sopher Original Forceps 10½" (267mm) Medium Jaws

### Hern Evacuation Forceps

Slightly curved forceps with coarse teeth, oval jaws.

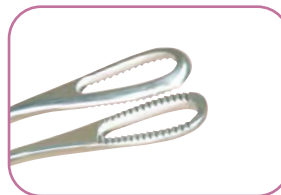
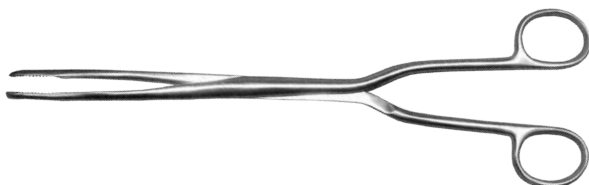

- 031146 Hern Evacuation Forceps 13" (330mm) Small 12mm Jaws
- 031147 Hern Evacuation Forceps 13" (330mm) Medium 15mm Jaws
- 031148 Hern Evacuation Forceps 13" (330mm) Large 19mm Jaws

## MedGyn Ovum Forceps

### Hern-Patterson Forceps

Straight forceps with coarse teeth, oval jaws and ratchet.

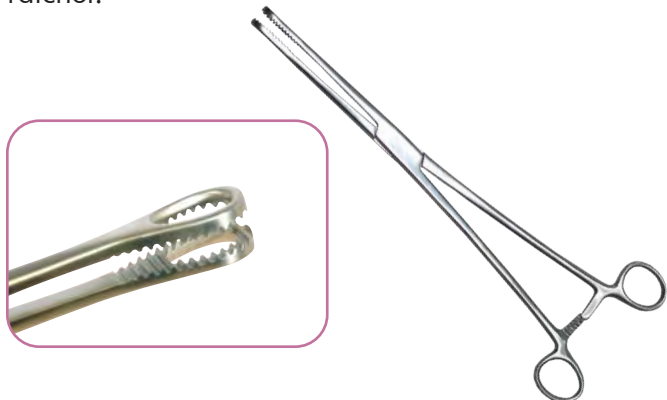

031139 Hern Patterson Evacuation Forceps 13" (330mm) 17mm Jaws

### Agadi-Bierer Forceps



031153 Agadi-Bierer Forceps 13" (330mm) - 14mm without Ratchet

031154 Agadi-Bierer Forceps 13" (330mm) - 14mm with Ratchet

### West-Gluck Forceps



031168 West-Gluck Forceps 11" (279mm)

### Hern Van-Lyth Forceps

Curved forceps with fine teeth.

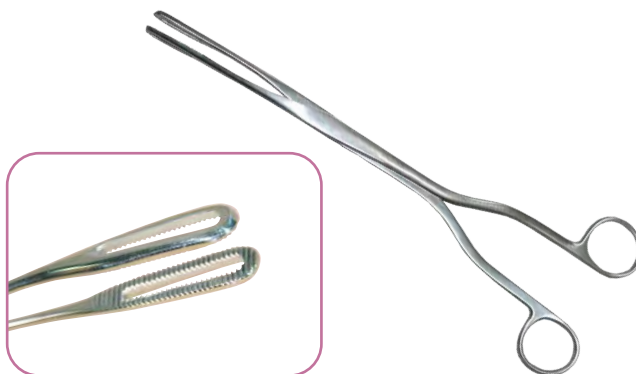

031166 Hern Van Lyth Evacuation Forceps 9½" (241mm) 9mm Jaws

031167 Hern Van Lyth Evacuation Forceps 10" (254mm) 11mm Jaws

### Ramplly Ring Forceps



031007 Ramplly with Oval Jaws 10" (254mm) Straight

### Stubblefield Forceps

Slightly curved, very long forceps with oval jaws.

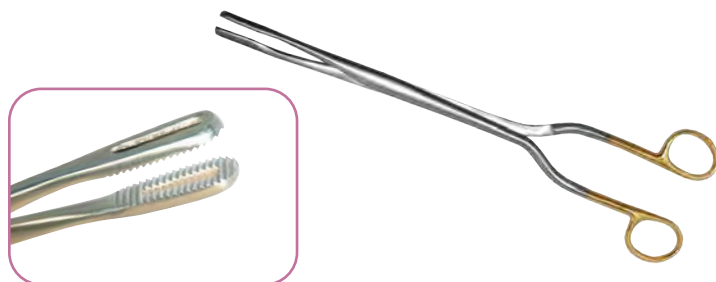

031144 Stubblefield Forceps 15" (381mm) 14mm Jaws



## MedGyn Ovum Forceps

### Agadi Evacuation Forceps

Smaller forceps available in both straight and curved versions with oval jaws.

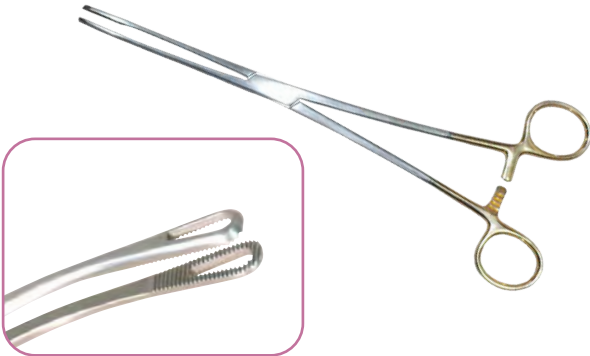

- 031170 Agadi Evacuation Forceps 9<sup>3</sup>/<sub>4</sub>" (248mm) Curved
- 031171 Agadi Evacuation Forceps 9<sup>1</sup>/<sub>2</sub>" (241mm) Straight

### Blumenthal Forceps

Slightly curved forceps with large oval jaws and coarse teeth.



- 031141 Blumenthal Evacuation Forceps 13" (330mm)  
20mm Jaws

### Saenger Forceps

Forceps with unique inner-diameter teeth within oval jaws.

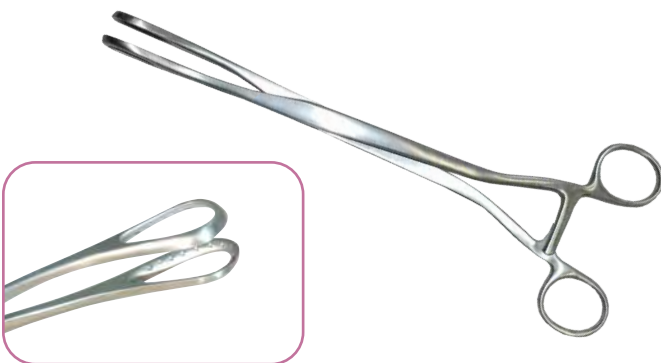

- 031163 Saenger Ovum Forceps 11<sup>1</sup>/<sub>4</sub>" (286mm) Curved
- 031164 Saenger Ovum Forceps 10<sup>3</sup>/<sub>4</sub>" (273mm) Straight with Ratchet
- 031165 Saenger Ovum Forceps 10<sup>1</sup>/<sub>2</sub>" (267mm) Curved with Ratchet
- 031172 Saenger Ovum Forceps 13" (330mm) Straight with Ratchet

### Boston Forceps

Straight forceps with large oval jaws and coarse teeth.



- 031156 Boston Evacuation Forceps 13<sup>1</sup>/<sub>2</sub>" (343mm)  
27mm Jaws - High Fulcrum
- 031157 Boston Evacuation Forceps 13<sup>1</sup>/<sub>2</sub>" (343mm)  
27mm Jaws - Low Fulcrum

### Jacobson Forceps

Slightly curved forceps, with coarse teeth, oval jaw and enlarged ring handles. With concave tip.



- 031142 Jacobson Evacuation Forceps 13" (330mm)  
Large with 20mm Jaws

## MedGyn Ovum Forceps

### Meltzer Forceps

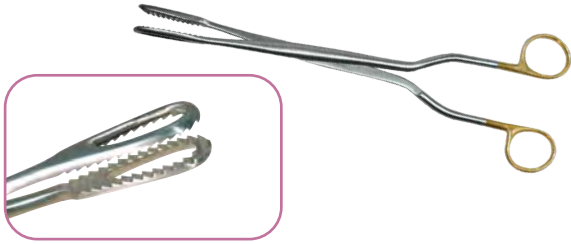

031143 Meltzer Evacuation Forceps 13" (330mm)  
19mm Jaws

### Fink Forceps

Slightly curved with jaws and concave tip.

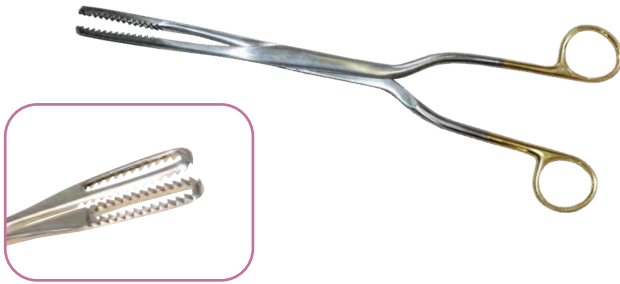

031176 Fink Ovum Forceps 10½" (267mm)  
13mm Jaws

## MedGyn Placenta Forceps

### Hern-Barret Placenta Forceps

Slightly curved placenta forceps with oval jaws.

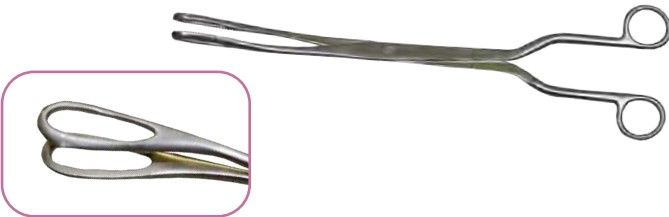

031151 Hern-Barret Placenta Forceps 13" (330mm)  
16mm Serrated Jaws

031152 Hern-Barret Placenta Forceps 13" (330mm)  
16mm Smooth Jaws

### Hern-Kelly Placenta Forceps

Slightly curved placenta forceps with serrated jaws.



031145 Hern-Kelly 13" (330mm)  
19mm Serrated Jaws

### McClintock Forceps

Slightly curved with fine-tooth jaws.



031122 McClintock Ovum Forceps 9½"  
(241mm) 14mm Jaws

### Lisa Forceps

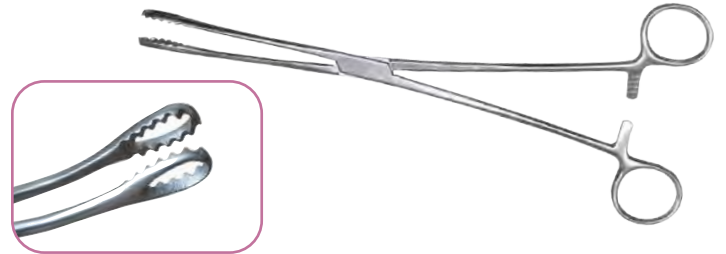

031173 Lisa Forceps 10" (254mm)

### Kelly Placenta Forceps

Slightly curved placenta forceps with serrated jaws.



031140 Kelly Placenta Forceps 12.5" (318mm)  
19mm Serrated Jaws

## MedGyn Myoma Grasping

### Myoma Grasping Forceps

Ideal for transcervical management of polyps and pedunculated myoma.

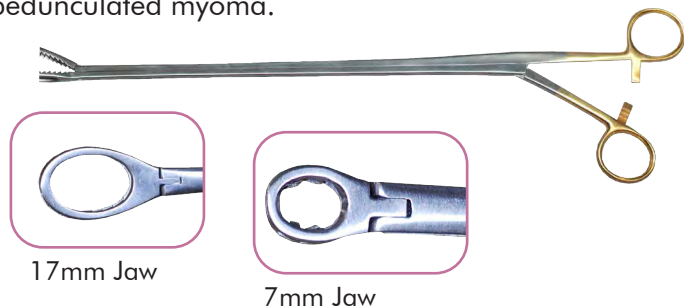

- 031210 Myoma Grasping Forceps 13" (330mm) 7mm Jaws
- 031211 Myoma Grasping Forceps 13" (330mm) 11mm Jaws
- 031212 Myoma Grasping Forceps 13" (330mm) 17mm Jaws

## MedGyn Tissue Forceps

- 031107 Allis Tissue Forceps 4" (104mm) 4x5 Teeth
- 031105 Allis Tissue Forceps 5" (127mm) 4x5 Teeth
- 031108 Allis Tissue Forceps 6" (152mm) 4x5 Teeth
- 031109 Allis Tissue Forceps 6" (152mm) 5x6 Teeth
- 031110 Allis Tissue Forceps 7½" (190mm) 5x6 Teeth
- 031103 Allis Tissue Forceps 9½" (241mm) 5x6 Teeth
- 031106 Allis Tissue Forceps 10" (254mm) 5x6 Teeth
- 031104 Allis Tissue Forceps 6" (152mm) 4x5 Teeth with Angular Jaws
- 031101 Allis Tissue Forceps 6" (152mm) 5x6 Teeth with Angular Jaws
- 031102 Allis Tissue Forceps 7¼" (184mm) 5x6 Teeth with Angular

### Allis Tissue Forceps

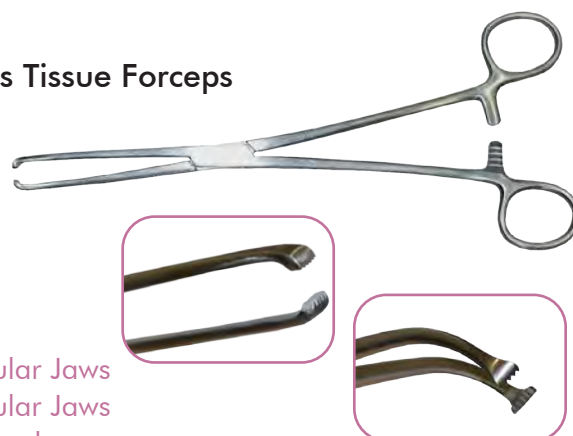

### Baby Allis Tissue Forceps



- 031111 Baby Allis Forceps 5½" (140mm) 4x5 Teeth-Extra Delicate Jaws
- 031112 Baby Allis Forceps 5" (127mm) 4x5 Teeth-Extra Delicate Jaws

### Ochsner Tissue Forceps



- 031169 Ochsner Tissue Forceps

### Adson Tissue Forceps



- 031196 Adson Tissue Forceps 4¾" (121mm) 1x2 Teeth

### Tissue Forceps



- 031180 Tissue Forceps 8" (203mm) Small 1x2 Teeth
- 031181 Tissue Forceps 10" (254mm) Large 1x2 Teeth

## MedGyn Polyp Forceps

### Polyp Forceps

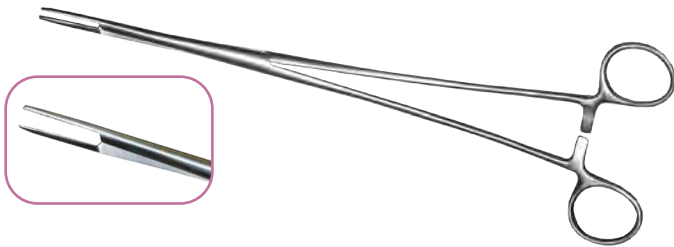

031121 Polyp Forceps 10" (254mm) Narrow Jaws

### Fletcher Forceps

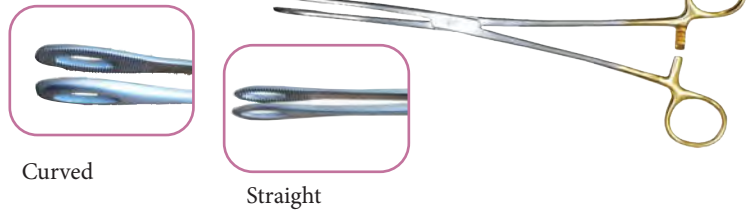

Curved

Straight

031014 Fletcher with Oval Jaws 9½" (241mm) Straight

### Alligator Forceps

Perfect design for retrieval of IUDs, with hinged serrated jaws.



030112 Alligator Forceps 8" (203mm)

030112-11 Alligator Forceps 11" (279mm)

### IUD Hooks

For IUD retrieval; available in single and double notch versions.

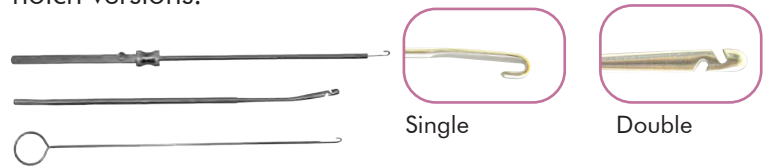

Single

Double

031306 IUD Hook 10" (254mm) Single Notch

031307 IUD Hook 10½" (265mm) Double Notch

031308 IUD Hook Universal 12½" (318mm)

031035 Foerster Dressing Forceps 9½" (241mm) Straight - Serrated Jaws

031037 Foerster Dressing Forceps 9½" (241mm) Straight - Smooth Jaws

031036 Foerster Dressing Forceps 9½" (241mm) Curved - Serrated Jaws

031038 Foerster Dressing Forceps 9½" (241mm) Curved - Smooth Jaws

### Foerster Dressing Forceps



### Dressing Forceps

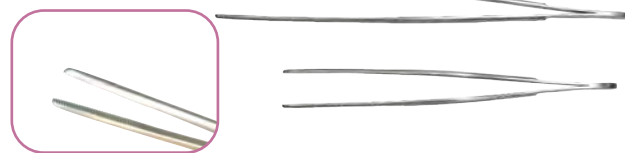

031186 Dressing Forceps 8" (203mm)

031187 Dressing Forceps 10" (254mm)

### Bozeman Uterine Dressing Forceps



031161 Bozeman Uterine Dressing 10½" (267mm) Straight

031162 Bozeman Uterine Dressing 10½" (267mm) Curved

031162-ECO Bozeman Uterine Dressing 10½" (267mm) Curved - Economy

### Halsted Mosquito Forceps

031113 Halsted Mosquito Hemostatic Forceps Straight 5" (127mm)

031114 Halsted Mosquito Hemostatic Forceps Straight with Delicate Teeth 5" (127mm)

031115 Halsted Mosquito Hemostatic Forceps Straight with 1x2 Teeth 5" (127mm)

031116 Halsted Mosquito Hemostatic Forceps Curved 5" (127mm)

031118 Halsted Mosquito Hemostatic Forceps Curved with Delicate Teeth 5" (127mm)

031119 Halsted Mosquito Hemostatic Forceps Curved with 1x2 Teeth 5" (127mm)

031116-ECO Halsted Mosquito Hemostatic Forceps Economy 5" (127mm)



## MedGyn Long-Reach Instruments

### Allis Tissue Forceps

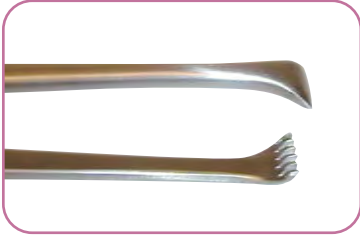

- 031099 Allis Forceps 12" (305mm) 5x6 Teeth
- 031100 Allis Forceps 14" (356mm) 5x6 Teeth

### Babcock Tissue Forceps

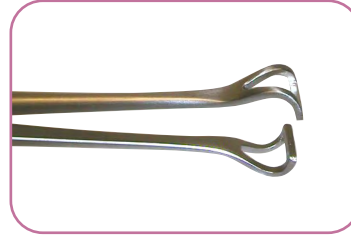

- 031188 Babcock Tissue Forceps 12" (305mm)
- 031189 Babcock Tissue Forceps 14" (356mm)
- 031190 Babcock Tissue Forceps 18" (457mm)

### DeBakey Tissue Forceps



- 031182 DeBakey Tissue Forceps 12" (305mm)
- 031183 DeBakey Tissue Forceps 14" (356mm)

### Gemini Forceps



- 031192 Gemini Forceps 14" (356mm) Curved

## MedGyn Long-Reach Instruments

### Crile Wood Needle Holder

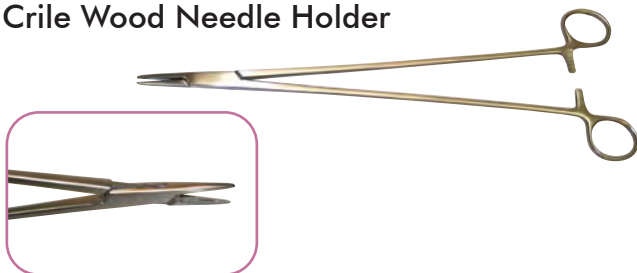

- 040085 Crile Wood Needle Holder 12" (305mm)
- 040086 Crile Wood Needle Holder 14" (356mm)

### Clark Hysterectomy Forceps



- 031193 Clark Hysterectomy Forceps 12" (305mm)
- 031194 Clark Hysterectomy Forceps 14" (356mm)

### Jorgenson Scissors



- 031177 Jorgenson Scissors 14" (356mm) Curved

## MedGyn Needle Adapters - Extenders

An effective means of extending ordinary hypodermic needles when longer needles are required. The paracervical and uterosacral areas can easily be reached with an extended needle.



### Needle Adapters

- 030501 Needle Adapter 3" (76mm)
- 030502 Needle Adapter 4" (102mm)
- 030503 Needle Adapter 5" (127mm)
- 030504 Needle Adapter 6" (152mm)

### Rochester Ochsner Forceps



- 031184 Rochester Ochsner Forceps 12" (305mm) Curved
- 031185 Rochester Ochsner Forceps 14" (356mm) Curved

### Kocher Forceps

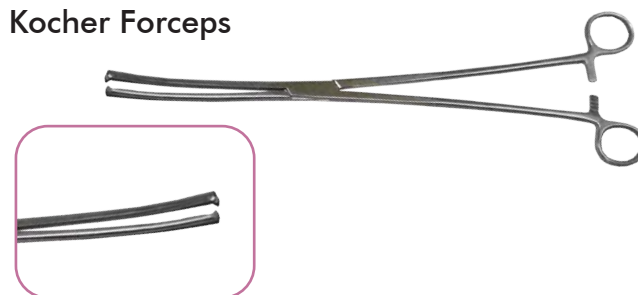

- 031195 Kocher Forceps Curved 14" (356mm)

### Metzenbaum Scissors

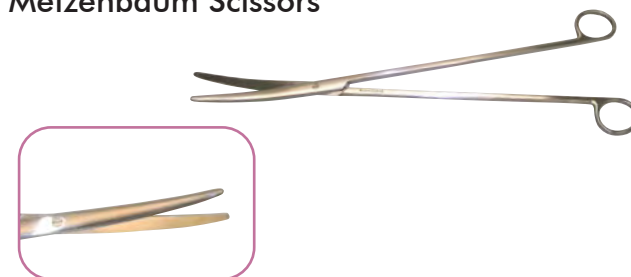

- 040091 Metzenbaum Scissors Curved 14" (356mm)
- 040092 Metzenbaum Scissors Straight 14" (356mm)

## MedGyn Hysterectomy Clamps

### Hysterectomy ("Z")- Clamps



- 040025 Hysterectomy Clamp 8 1/4" (210mm) - Straight
- 040026 Hysterectomy Clamp 8 1/4" (210mm) - Slight Curve
- 040027 Hysterectomy Clamp 8 1/4" (210mm) - Full Curve
- 040028 Hysterectomy Clamp 8 1/4" (210mm) - Angled
- 040035 Hysterectomy Clamp 9 1/2" (241mm) - Straight
- 040036 Hysterectomy Clamp 9 1/2" (241mm) - Slight Curve
- 040037 Hysterectomy Clamp 9 1/2" (241mm) - Strong Curve
- 040038 Hysterectomy Clamp 9 1/2" (241mm) - Angled
- 040045 Hysterectomy Clamp 12" (305mm) - Straight
- 040046 Hysterectomy Clamp 12" (305mm) - Slight Curve

- 040047 Hysterectomy Clamp 12" (305mm) - Strong Curve
- 040048 Hysterectomy Clamp 12" (305mm) - Angled
- 040055 Hysterectomy Clamp 14" (356mm) - Straight
- 040056 Hysterectomy Clamp 14" (356mm) - Slight Curve
- 040057 Hysterectomy Clamp 14" (356mm) - Strong Curve
- 040058 Hysterectomy Clamp 14" (356mm) - Angled
- 040015 Hysterectomy Clamp 16" (406mm) - Straight
- 040016 Hysterectomy Clamp 16" (406mm) - Slight Curve
- 040017 Hysterectomy Clamp 16" (406mm) - Strong Curve
- 040018 Hysterectomy Clamp 16" (406mm) - Angled

## MedGyn Hysterectomy Forceps

### Pean Hysterectomy Forceps - Straight

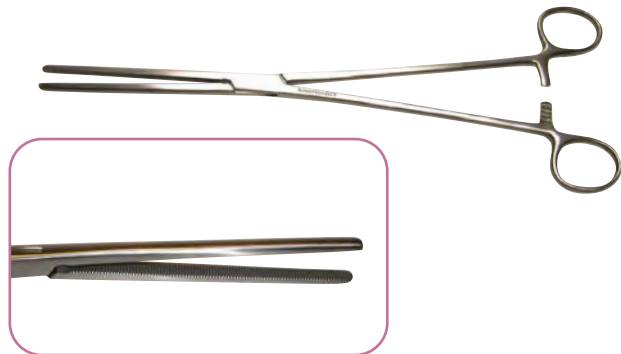

030999 Pean Hysterectomy Forceps Straight 8" (203mm)

### Pean Hysterectomy Forceps - Curved

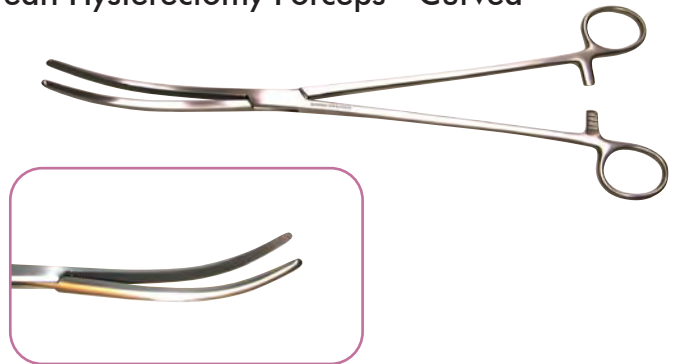

031000 Pean Hysterectomy Forceps Curved 8" (203mm)

## MedGyn Hysterectomy Scissors

- 041125 Hysterectomy Scissors 9" (229mm) - Slight Curve
- 041126 Hysterectomy Scissors 9" (229mm) - Curve
- 041127 Hysterectomy Scissors 9" (229mm) - Full Curve
- 041128 Hysterectomy Scissors 9" (229mm) - Angled
- 041135 Hysterectomy Scissors 10 1/2" (267mm) - Slight Curve
- 041136 Hysterectomy Scissors 10 1/2" (267mm) - Curve
- 041137 Hysterectomy Scissors 10 1/2" (267mm) - Full Curve
- 041138 Hysterectomy Scissors 10 1/2" (267mm) - Angled

- 041145 Hysterectomy Scissors 12" (305mm) - Slight Curve
- 041146 Hysterectomy Scissors 12" (305mm) - Curve
- 041147 Hysterectomy Scissors 12" (305mm) - Full Curve
- 041148 Hysterectomy Scissors 12" (305mm) - Angled
- 041155 Hysterectomy Scissors 14" (356mm) - Slight Curve
- 041156 Hysterectomy Scissors 14" (356mm) - Curve
- 041157 Hysterectomy Scissors 14" (356mm) - Full Curve
- 041158 Hysterectomy Scissors 14" (356mm) - Angled

## MedGyn Scissors

### Metzenbaum Scissors - Straight



- 041026 Metzenbaum 5" (127mm) - Standard Straight
- 041028 Metzenbaum 6" (152mm) - Standard Straight
- 041030 Metzenbaum 7" (178mm) - Standard Straight
- 041032 Metzenbaum 8" (203mm) - Standard Straight
- 041034 Metzenbaum 9" (229mm) - Standard Straight
- 041036 Metzenbaum 10" (254mm) - Standard Straight
- 041038 Metzenbaum 11" (279mm) - Standard Straight
- 041040 Metzenbaum 12" (305mm) - Standard Straight
- 041026-DEL Metzenbaum 5" (127mm) - Delicate Straight
- 041028-DEL Metzenbaum 6" (152mm) - Delicate Straight
- 041030-DEL Metzenbaum 7" (178mm) - Delicate Straight
- 041032-DEL Metzenbaum 8" (203mm) - Delicate Straight
- 041034-DEL Metzenbaum 9" (229mm) - Delicate Straight

### Operating Scissors - Straight



- 042000-S Straight Scissors 4½" (114mm) - Blunt/Blunt
- 042001-S Straight Scissors 4½" (114mm) - Sharp/Blunt
- 042002-S Straight Scissors 4½" (114mm) - Sharp/Sharp
- 042004-S Straight Scissors 5" (127mm) - Blunt/Blunt
- 042003-S Straight Scissors 5" (127mm) - Sharp/Blunt
- 042005-S Straight Scissors 5" (127mm) - Sharp/Sharp
- 042006-S Straight Scissors 5½" (140mm) - Blunt/Blunt
- 042007-S Straight Scissors 5½" (140mm) - Sharp/Blunt
- 042008-S Straight Scissors 5½" (140mm) - Sharp/Sharp
- 042009-S Straight Scissors 6" (152mm) - Blunt/Blunt
- 042010-S Straight Scissors 6" (152mm) - Sharp/Blunt
- 042011-S Straight Scissors 6" (152mm) - Sharp/Sharp
- 042012-S Straight Scissors 6½" (165mm) - Blunt/Blunt
- 042013-S Straight Scissors 6½" (165mm) - Sharp/Blunt
- 042014-S Straight Scissors 6½" (165mm) - Sharp/Sharp
- 042015-S Straight Scissors 7½" (191mm) - Sharp/Blunt
- 042016-S Straight Scissors 7½" (191mm) - Blunt/Blunt

### Doyen Scissors



- 041075 Doyen Scissors 7" (178mm) - Curved/Smooth
- 041076 Doyen Scissors 7" (178mm) - Straight/Smooth
- 041077 Doyen Scissors 7" (178mm) - Curved/Serrated
- 041078 Doyen Scissors 7" (178mm) - Straight/Serrated

### Metzenbaum Scissors - Curved



- 041025 Metzenbaum 5" (127mm) - Standard Curved
- 041027 Metzenbaum 6" (152mm) - Standard Curved
- 041029 Metzenbaum 7" (178mm) - Standard Curved
- 041031 Metzenbaum 8" (203mm) - Standard Curved
- 041033 Metzenbaum 9" (229mm) - Standard Curved
- 041035 Metzenbaum 10" (254mm) - Standard Curved
- 041037 Metzenbaum 11" (279mm) - Standard Curved
- 041039 Metzenbaum 12" (305mm) - Standard Curved
- 041025-DEL Metzenbaum 5" (127mm) - Delicate Curved
- 041027-DEL Metzenbaum 6" (152mm) - Delicate Curved
- 041029-DEL Metzenbaum 7" (178mm) - Delicate Curved
- 041031-DEL Metzenbaum 8" (203mm) - Delicate Curved
- 041033-DEL Metzenbaum 9" (229mm) - Delicate Curved

### Operating Scissors - Curved



- 042000-C Curved Scissors 4½" (114mm) - Blunt/Blunt
- 042001-C Curved Scissors 4½" (114mm) - Sharp/Blunt
- 042002-C Curved Scissors 4½" (114mm) - Sharp/Sharp
- 042004-C Curved Scissors 5" (127mm) - Blunt/Blunt
- 042003-C Curved Scissors 5" (127mm) - Sharp/Blunt
- 042005-C Curved Scissors 5" (127mm) - Sharp/Sharp
- 042006-C Curved Scissors - 5½" (140mm) - Blunt/Blunt
- 042007-C Curved Scissors 5½" (140mm) - Sharp/Blunt
- 042008-C Curved Scissors 5½" (140mm) - Sharp/Sharp
- 042009-C Curved Scissors 6" (152mm) - Blunt/Blunt
- 042010-C Curved Scissors 6" (152mm) - Sharp/Blunt
- 042011-C Curved Scissors 6" (152mm) - Sharp/Sharp
- 042012-C Curved Scissors 6½" (165mm) - Blunt/Blunt
- 042013-C Curved Scissors 6½" (165mm) - Sharp/Blunt
- 042014-C Curved Scissors 6½" (165mm) - Sharp/Sharp
- 042015-C Curved Scissors 7½" (191mm) - Sharp/Blunt

### IUD Scissors



- 041010 IUD Scissors Curved 10" (254mm)



## MedGyn Scissors

### Mayo Scissors



- 041061 Straight Mayo Scissors 5½" (140mm)
- 041063 Straight Mayo Scissors 6¾" (171mm)
- 041070 Straight Mayo Scissor 8" (203mm)
- 041067 Straight Mayo Scissors 9" (229mm)
- 041071 Straight Mayo Scissor 10¼"(260mm)
- 041069 Straight Mayo Scissors 11" (279mm)



- 041060 Curved Mayo Scissors 5½" (140mm)
- 041062 Curved Mayo Scissors 6¾" (171mm)
- 041064 Curved Mayo Scissors 8" (203mm)
- 041066 Curved Mayo Scissors 9" (229mm)
- 041068 Curved Mayo Scissors 11" (279mm)

### Iris Scissors



- 041100 Iris Scissors 3½" (89mm), 20mm Blades Delicate Curved
- 041101 Iris Scissors 3½" (89mm), 20mm Blades Delicate Straight
- 041102 Iris Scissors 3¾" (95mm), 14mm Blades Curved Ribbon Type
- 041103 Iris Scissors 3¾" (95mm), 14mm Blades Straight Ribbon Type
- 041104 Iris Scissors 4½" (114mm) Angled on Side
- 041105 Iris Scissors 4½" (114mm) Curved
- 041106 Iris Scissors 4½" (114mm) Curved Sideways
- 041107 Iris Scissors 4½" (114mm) Straight

### Potts-Smith Scissors

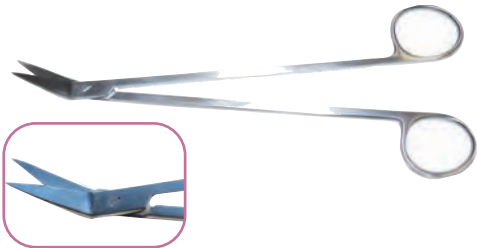

- 041015 Potts-Smith Scissors 7" (178mm), 13mm Blades, Delicate - Angled 25°
- 041016 Potts-Smith Scissors 7" (178mm), 13mm Blades, Delicate - Angled 45°
- 041017 Potts-Smith Scissors 7" (178mm), 13mm Blades, Delicate - Angled 60°
- 041018 Potts-Smith Scissors 7½" (191mm), 20mm Blades, Delicate - Angled 25°
- 041019 Potts-Smith Scissors 7½" (191mm), 20mm Blades, Delicate - Angled 45°
- 041020 Potts-Smith Scissors 7½" (191mm), 20mm Blades, Delicate - Angled 60°

### Kelly-Adson Scissors

- 041085 Kelly-Adson 6¼" (159mm) Smooth/Straight
- 041086 Kelly-Adson 6¼" (159mm) Serrated/Straight
- 041087 Kelly-Adson 6¼" (159mm) Smooth/Curved



### Lister Scissors

- 041050 Lister Bandage Scissors 3½" (89mm) Extra Fine
- 041051 Lister Bandage Scissors 4½" (114mm) Extra Fine
- 041052 Lister Bandage Scissors 5½" (140mm) Extra Fine
- 041053 Lister Bandage Scissors 7¼" (184mm) Extra Fine
- 041054 Lister Bandage Scissors 8" (203mm) with  
One Larger Finger Ring



### Spencer Scissors



- 041095 Spencer Stitch Scissors 3½" (89mm) Delicate

### Sweet Scissors



- 041096 Sweet Scissors 8½" (216mm) Angled on Flat

### Littauer Scissors



- 041088 Littauer Stitch Scissors 4½" (114mm) Light
- 041089 Littauer Stitch Scissors 5½" (140mm) Standard
- 042099-ECO Littauer Stitch Scissor 4½" (114mm)  
Economy

## MedGyn Needle Holders

### Webster Needle Holder



- 040075 Webster Needle Holder 5" (127mm) Serrated Jaws
- 040076 Webster Needle Holder 5" (127mm) Smooth Jaws

### Mayo-Hegar Needle Holder



- 040093 Mayo-Hegar Needle Holder 5" (127mm) Serrated
- 040094 Mayo-Hegar Needle Holder 6" (152mm) Serrated
- 040095 Mayo-Hegar Needle Holder 7" (178mm) Serrated
- 040096 Mayo-Hegar Needle Holder 8" (203mm) Serrated

### Olsen-Hegar Needle Holder/Scissors

- 040097 Olsen-Hegar Needle Holder/Scissors 4<sup>3</sup>/<sub>4</sub>" (121mm) Serrated Extra Delicate
- 040098 Olsen-Hegar Needle Holder/Scissors 4<sup>3</sup>/<sub>4</sub>" (121mm) Smooth Extra Delicate
- 040099 Olsen-Hegar Needle Holder/Scissors 5<sup>1</sup>/<sub>2</sub>" (140mm) Serrated
- 040100 Olsen-Hegar Needle Holder/Scissors 6<sup>1</sup>/<sub>2</sub>" (165mm) Serrated
- 040101 Olsen-Hegar Needle Holder/Scissors 7<sup>1</sup>/<sub>4</sub>" (184mm) Serrated



### Heaney Needle Holder



- 040071 Heaney Needle Holder 8<sup>1</sup>/<sub>2</sub>" (216mm) Curved Jaws

### Mathieu Needle Holder



- 040072 Mathieu Needle Holder 5<sup>1</sup>/<sub>2</sub>" (140mm) w/Spring Handles
- 040073 Mathieu Needle Holder 6<sup>1</sup>/<sub>4</sub>" (159mm) w/Spring Handles
- 040074 Mathieu Needle Holder 7<sup>1</sup>/<sub>2</sub>" (191mm) w/Spring Handles

### Crile-Wood Needle Holder



- 040081 Crile-Wood Needle Holder 6" (152mm)
- 040082 Crile-Wood Needle Holder 7" (178mm)
- 040083 Crile-Wood Needle Holder 8" (203mm)
- 040084 Crile-Wood Needle Holder 9" (229mm)
- 040087 Crile-Wood Needle Holder 10<sup>1</sup>/<sub>2</sub>" (267mm)

## Miscellaneous Products



- 040004 Emesis Basin Medium 8" (203mm)
- 040005 Emesis Basin Large 10" (254mm)
- 040003 Emesis Basin Small 6" (152mm)



- 040008 Iodine Cup 6oz



- 040001 Medicine Cup (2 oz.)

- 040009 Instrument Cleaner 8oz Bottle
- 040000 Instrument Lubricant Spray - 8oz
- 040010 Instrument Stain Remover 3oz
- 040002 Instrument Steel Tray - 12<sup>1</sup>/<sub>4</sub>" X 7<sup>1</sup>/<sub>2</sub>" X 2<sup>1</sup>/<sub>2</sub>" (Graham 3259)



# GENERAL GYNECOLOGY

## PROCEDURE

- General Procedures
- Pap Smear
- Laparoscopy
- Hysteroscopy

- Speculum
- Tenaculum
- Forceps
- Cell Sweep
- Cervical Brush
- Uterine Manipulator
- Hysteroscopy Instruments
- Endoscopic Cannula

# UROGYNECOLOGY



## PROCEDURE

Pessary Insertion

### Pessary Types:

- Ring
- Ring with Knob
- Cerclage
- Donut
- Gellhorn
- Shaatz
- Cube
- Pessary Case
- Cup
- Dish
- Gehrung
- Hodge
- Marland
- Oval

## PROCEDURE

- Cervical Cancer Screening
- Cervical Biopsy
- Endometrial Biopsy
- Colposcopy
- Electrosurgery
- Cryotherapy

- Cell Sweep®/Cervical Brush
- Biopsy Punch
- Monsel's
- Endocervical Speculum
- Endocervical Curette
- Endosampler™
- Pipette
- Colposcope
- Lletz Generator,
- Electrode, Instr
- Cryotherapy
- Unit & Tips

## PROCEDURE

Pregnancy Testing  
Fetal Monitoring  
Labor and Delivery

- HCG Pregnancy Test
- Fetal Monitor
- Doppler
- Ultrasound
- Amnio Hook
- Umbilical Cord Clamp
- Vacuum Delivery Cup



# MedGyn

## for WOMEN'S LIFECYCLE



# FAMILY PLANNING

## PROCEDURE

IUD Insertion  
Dilation and  
Curettage

- IUD Kit
- Curette
- Collection Set
- Laminaria
- Aspiration Kit

## PROCEDURE

Insemination  
Hysterosalpingography  
Endometrial Biopsy

- IUI
- HSG Catheter
- Uterine Sound
- Endosampler™
- Pipette



# INFERTILITY

# OBSTETRICS



# GYNECOLOGY ONCOLOGY





Main: **1.630.627.4105**

Toll-Free: **1.800.451.9667**

Fax: **1.630.627.0127**

Email: **info@medgyn.com**

Web: **www.medgyn.com**

